

**KAUFMANN**  
WERBEGESCHENKE



*Wir haben Ideen!*



**JUGENDWETTBEWERB**

**KATALOG  
2024**







**52 226CL**  
**12 TLG. FASER MALSTIFTE**  
**XCLUB**  
**2,45 Euro**

←→ 10,5 x 16,5 x 3 cm  
 25/100

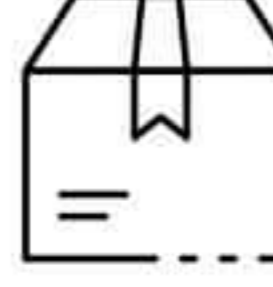

**52 205CL**  
**12ER JUMBOSTIFTE XCLUB**  
**2,98 Euro**

←→ 25,6 x 15,5 x 1,7cm  
 25/100 Stk.

*dickere  
Stifte  
speziell für  
Kinderhände!*

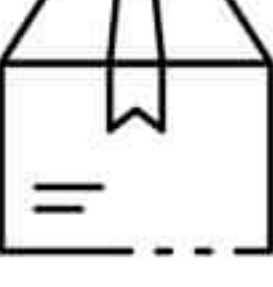

**52 206CL**  
**10ER BUNTSTIFTE XCLUB**  
**1,36 Euro**

←→ 18,5 x 14,5 x 1,5 cm  
 12/48 Stk.





**52 609CL**  
**15TLG. WASSERFARBEN MALSET**

**XCLUB**  
**1,96 Euro**

←→ 32,5 x 22 cm

☞ 10/200 Stk.

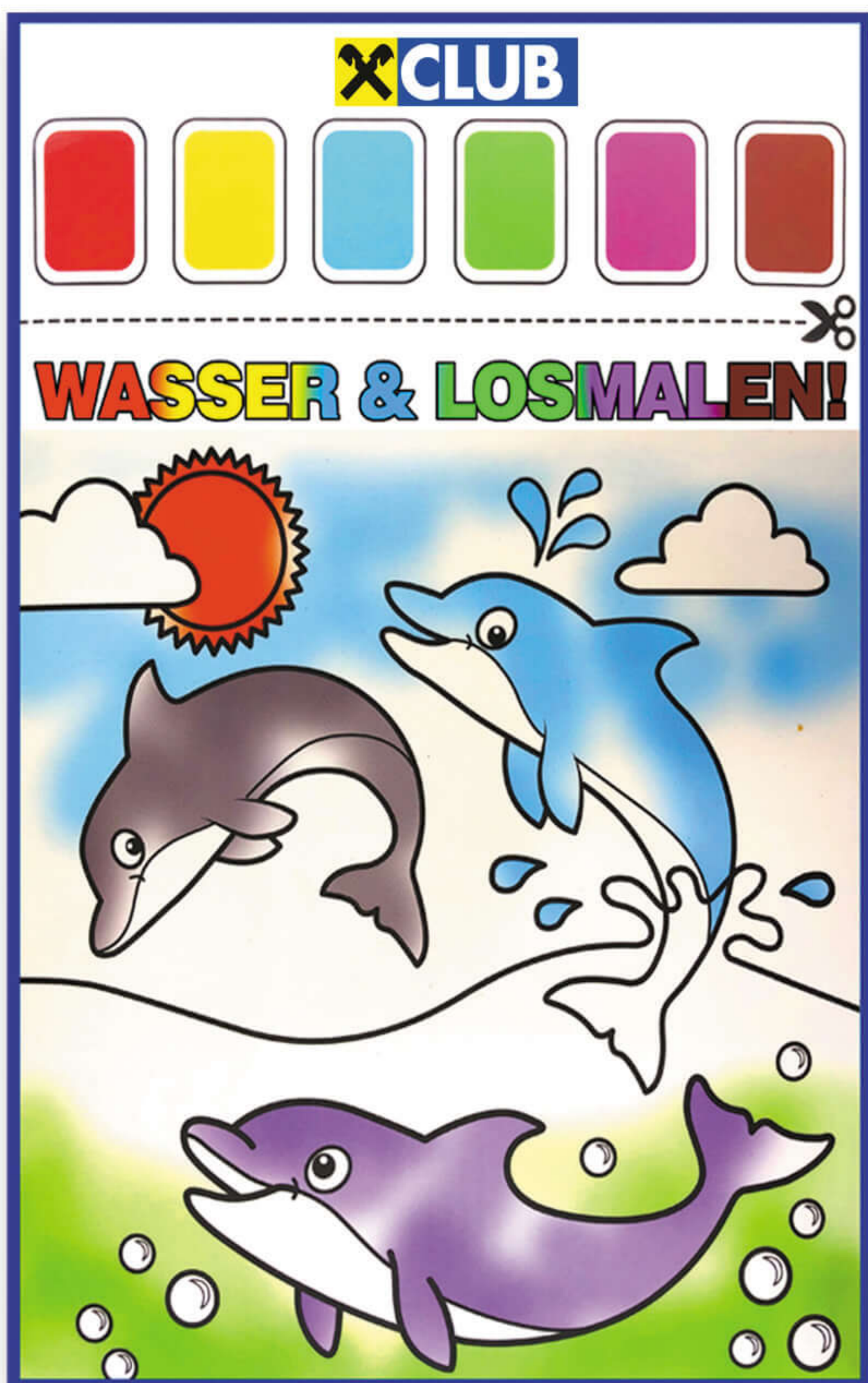

**52 411CL**  
**6 TLG. SCHREIBTAFEL SET XCLUB**

**2,29 Euro**

←→ 10 x 16 x 2 cm ☞ 24/48 Stk.



**52 403CL**  
**6TLG. STRASSENKREIDEN**  
**XCLUB**

**1,05 Euro**

←→ 15 x 11 x 2 cm

☞ 24/48 Stk.



**52 404CL**  
**15TLG. STRASSENKREIDEN**  
**XCLUB**

**2,71 Euro**

←→ 12 x 11 x 7,5 cm

☞ 10/30 Stk.







SET  
12 Buntstiften  
+  
Stiftehalter



**52 110CL**

13 TLG. MALSET **XCLUB**

**2,45 Euro**

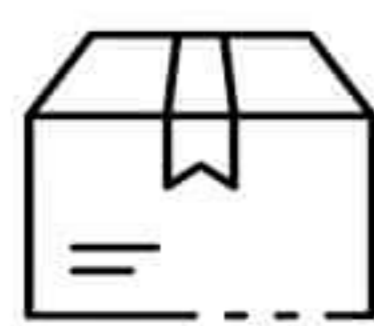
10,5 x 8,5 cm  50/100 Stk.

**3D**  
DESIGN



**52 108CL**

3D FEDERPENAL **XCLUB**

**2,37 Euro**

21 x 11 x 6 cm  50/100 Stk.







**52 109CL**

**3D STIFTEHALTER X CLUB**

**1,17 Euro**

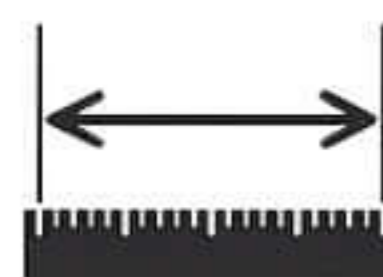
 10,5 x 8,5 cm

 50/100 Stk.



**52 100CL**

**3D SCHREIBTISCH UNTERLAGE**

**2,49 Euro**

 58 x 38 cm

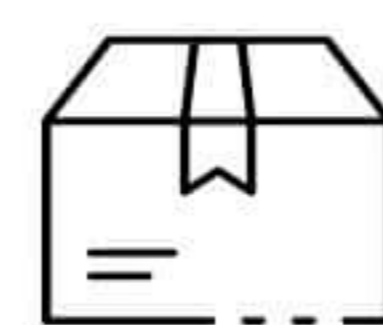
 10/50 Stk.

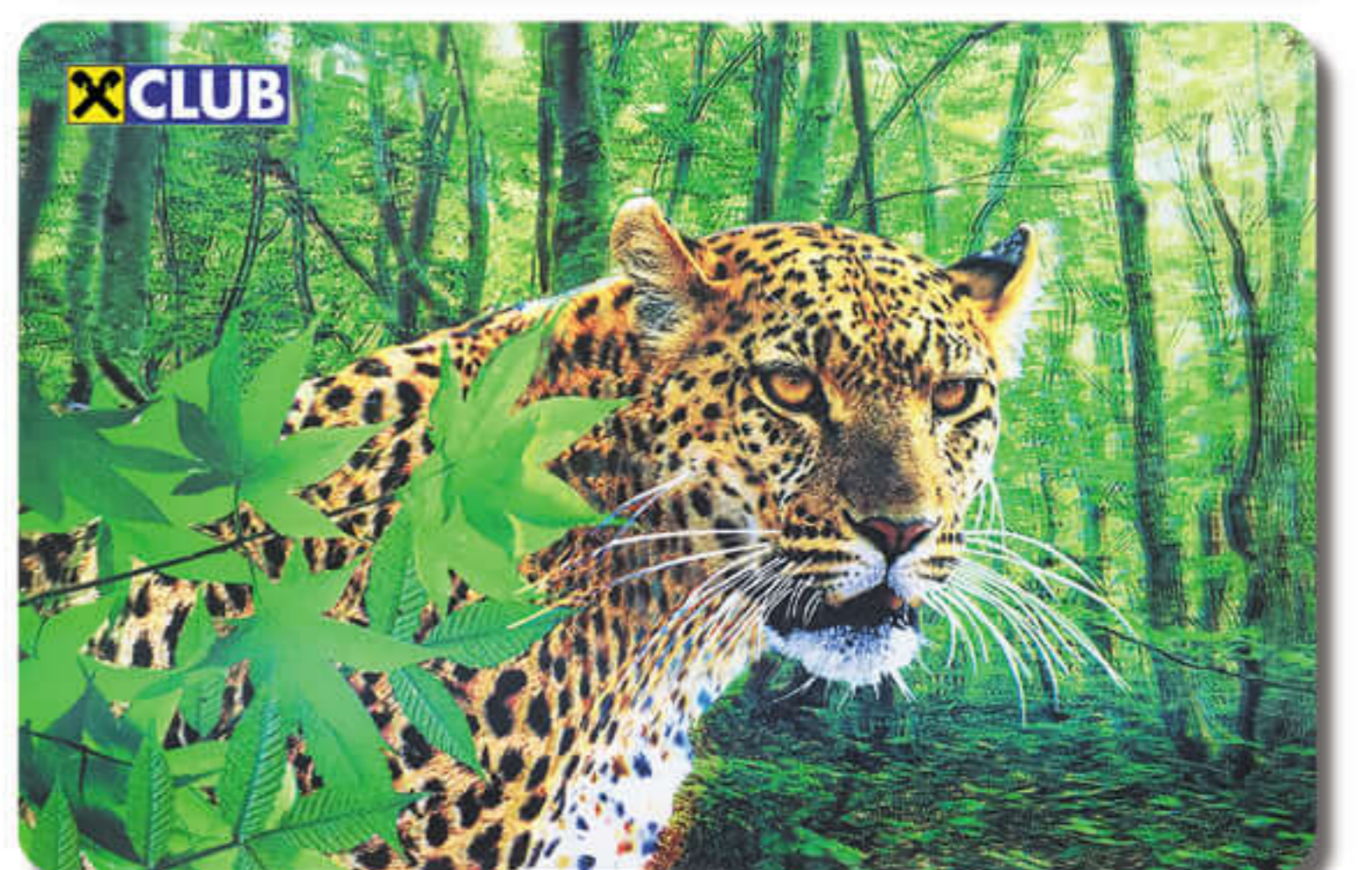



**A4 KINDER ERLEBNISBUCH**

**XCLUB**  
**52 619CL**  
**2,98 Euro**

A4 128 Seiten

80 Stk.



**A4**  
**FORMAT**  
**128**  
**SEITEN**  
**MALEN**  
**RÄTSEL**  
**2**  
**SEITEN**  
**STICKER**



**64 Seiten**  
**Malen**



**INKL. STIFTE**

**SUPER MALBUCH SET MIT 6 STIFTEN XCLUB**

**52 617CL**  
**2,45 Euro**

A4 64 Seiten

80 Stk.



mit 6 Buntstiften





 **8 cm**

**55 755CL**  
NOTIZBUCH FUSSBALL **XCLUB**

**0,87 Euro**  240 Stk.

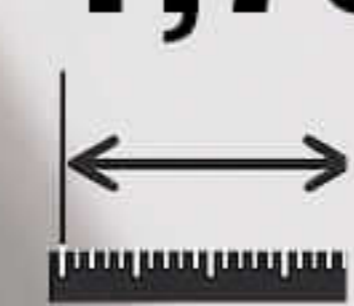
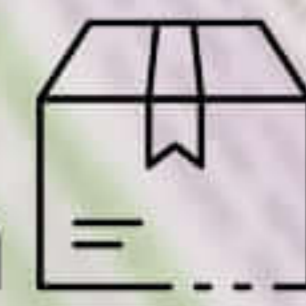

**55 255CL**  
5 TLG. MARKER SET „XCLUB“  
**1,79 Euro**

 7,5 X 7,5 X 7 cm  24 STK.

**54 197**  
KNAUTSCHBALL FUSSBALL  
**1,45 Euro**

 9 cm  50/250 Stk.

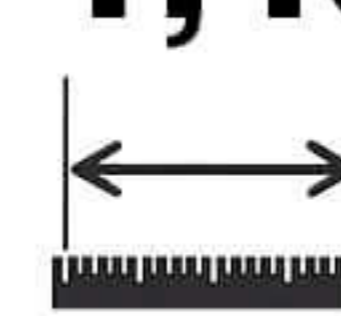
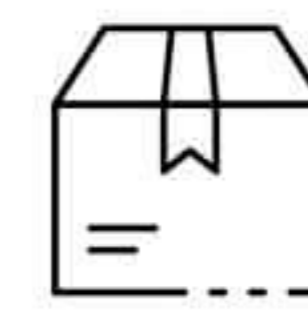

**54 194**  
ANTISTRESSBALL EINHORN  
**1,45 Euro**

 6 cm  24/96 STK.





**53 328CL**  
**3 TLG. KNETMASSE SET X CLUB**  
**1,65 Euro**

3 x 55gr.

24 STK



**53 707CL**  
**4 TLG. KNETMASSE SET X CLUB**  
**2,49 Euro**

22,5 x 6 x 6,5 cm

12/24 STK



**52 554**  
**RADIERGUMMI TIER**  
**0,40 Euro**

4 cm

36 Stk.



**60 092**  
**SCHLÜSELANHÄNGER TIER**  
**0,70 Euro**

7 cm

48/96 Stk.







**52 224CL**  
**KORDEL TASCHE**  
**MIT 5 STIFTEN XCLUB**  
**1,99 Euro**

30,5 x 22,5 cm

25/250 Stk.



**HOLZ BASTEL-**  
**BILDERRAHMEN XCLUB**

**52 410CL**  
**2,75 Euro**

22 x 24 x 3 cm

50/100 Stk.



*basteln*  
*kneten*  
*färben*







**54 175CL**  
**SPRINGBALL XCLUB**  
**1,19 Euro**  
6,5 cm  12/96 Stk.

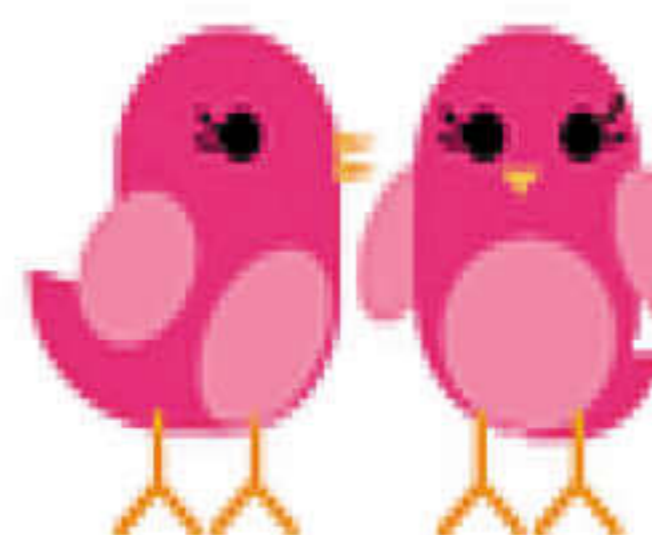
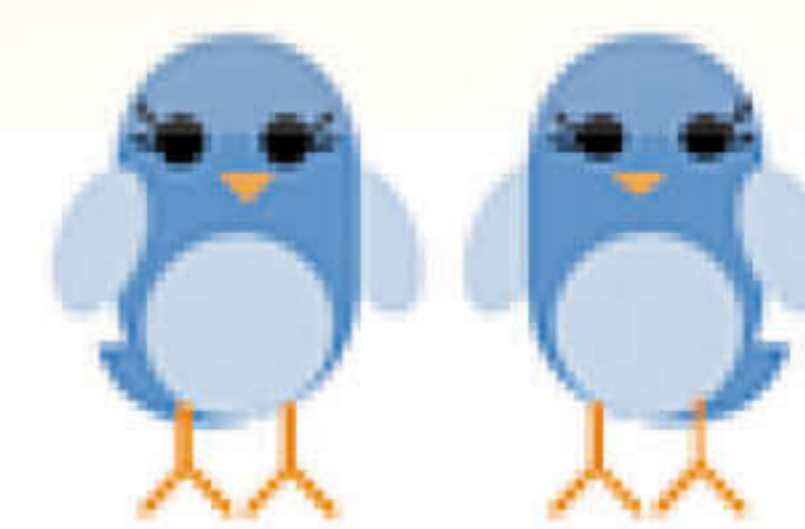
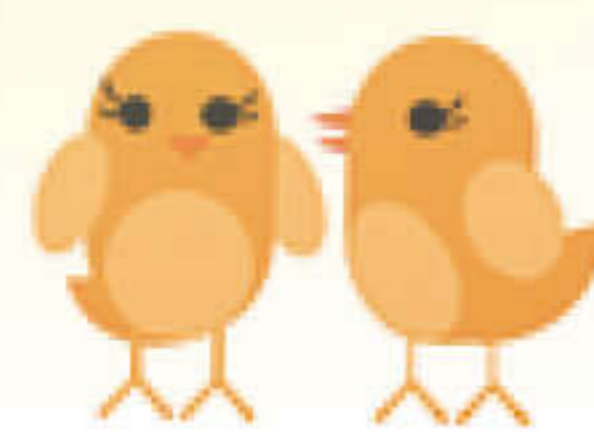
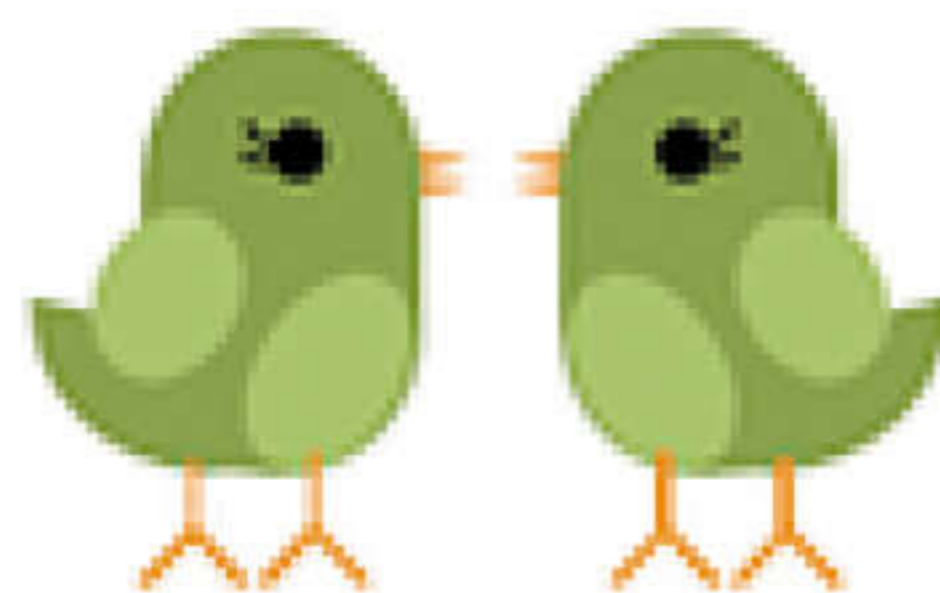

**53 326CL**  
**SEIFENBLASENSTAB DINO XCLUB**  
**1,89 Euro**  
38 cm lang  24 Stk.



**53 327CL**  
**SEIFENBLASENSTAB EINHORN XCLUB**  
**1,898 Euro**  
38 cm lang  24Stk.







**SPORTBEUTEL KINDER X CLUB**

**57 720CL**

**2,29 Euro**

30 x 35 CM  30/120 Stk.

**Feld zum Namenbeschriften**



**AUTOM. KINDERSCHIRM**

**X CLUB**

**58 202CL**

**3,15 Euro**

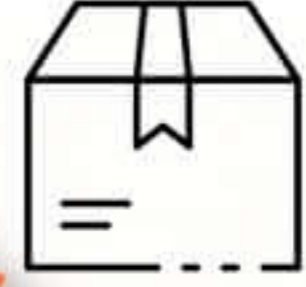
 25/150 Stk.





- + **UMWELTFREUNDLICH**
- + **AUS WEIZENSTROH**
- + **SPÜLMASCHINENFEST**
- + **MIKROWELLENGEEIGNET**
- + **EINFACHSTE VERWENDUNG**
- + **LEBENSMITTELECHT**



**62 140CL**  
**JAUSEDOSE KINDER XCLUB**

**2,55 Euro**

17,5 x 12 x 6,5 cm

30/60 Stk.



**0,3L GLASTRINKFLASCHE/  
HÜLLE XCLUB**

**61 275CL**

**2,69 Euro**

17 x 6 cm

25/50 Stk.



**6 BUNTE FARBEN**  
**VERWENDUNG**

- Diese hochwertige Trinkflasche wurde aus klarem und hitzebeständigem Glas gefertigt, wurde zusätzlich zu einer besseren & sichereren Verwendung mit einer ausfalligen EVA-Schutzkappe ausgestattet und ist somit:
- BPA- & Schadstoff frei
- spülmaschinenfest
- geschmacksneutral
- geschneidert
- hitzefest
- sehr robust
- rutschfest
- recyclebar
- ökologisch
- warmhaltend
- sehr stylisch

Da im Zuge des Produktionsprozesses evtl. Rückstände oder Verunreinigungen an Glas verbleiben, die Flasche vor ersten Verwendungsversuchen gründlich mit Spülmittel gut zu reinigen & immer in Geschirrspüler mit dem Hais nach unten zu waschen. Bitte seien Sie im Umgang mit Heißgetränken sehr vorsichtig, da die Hülle sich bei Gelähre auch beim Trinken heiß anfühlen kann, sich zu vermeiden.







**BASEBALLKAPPE KINDER XCLUB**

**58 706CL**

**2,95 Euro**

 0 - 6 Jahre

 25/150 Stk.



**KINDER SONNEN-/SCHNEEBRILLE XCLUB**

**60 306CL**

**2,45 Euro**

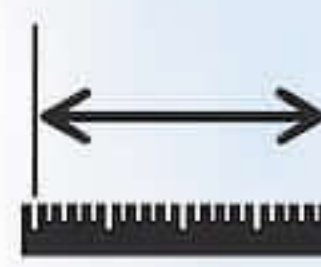
 4-10 Jahre

 25/250 Stk.









*perfekt für unterwegs*

**59 157CL**

**KINDER MIKROFASER LIEGETUCH **X**CLUB**

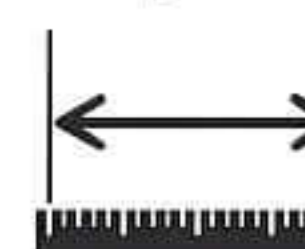
**6,90 Euro**

 50 x 110 cm

 12/48 Stk.

**BUNT**  
**WEICH**  
**LEICHT**  
**RECYCLEBAR**  
**PLATZSPAREND**  
**SEHR SAUGFÄHIG**  
**SANDABWEISEND**

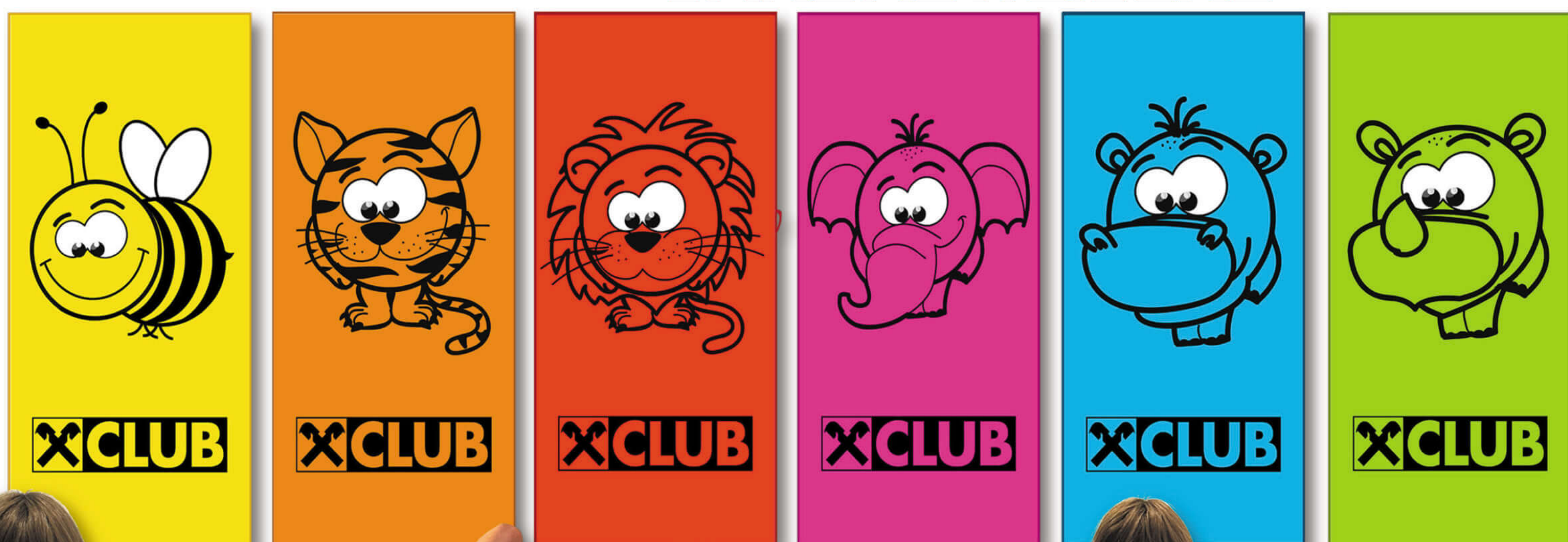

mit praktischer  
Schleufe





**54 152CL**  
**DIABOLO X CLUB**  
**2,75 Euro**

← 37 x 12 x 9 cm

☞ 48 Stk.



**MIT ECHTHOLZSTÄBCHEN!**



**53 548CL**  
**SUPER FLYER X CLUB**  
**2,38 Euro**

← 38 x 38 x 10 cm

☞ 60/120 Stk.



**54 192CL**  
**4 TLG. FANGBALLKORB-SET X CLUB**  
**2,70 Euro**

← 18 x 16 x 7 cm ☞ 50/100 Stk.

**54 191CL**  
**FANGBALLKORB MIT BALL X CLUB**  
**1,48 Euro**

← 18 x 8 x 7 cm ☞ 50/100 Stk.





**54 163CL**  
**3ER JONGLIERBÄLLE-SET**

**XCLUB**

**2,58 Euro**

16 x 6,5 cm

25/50 Stk.

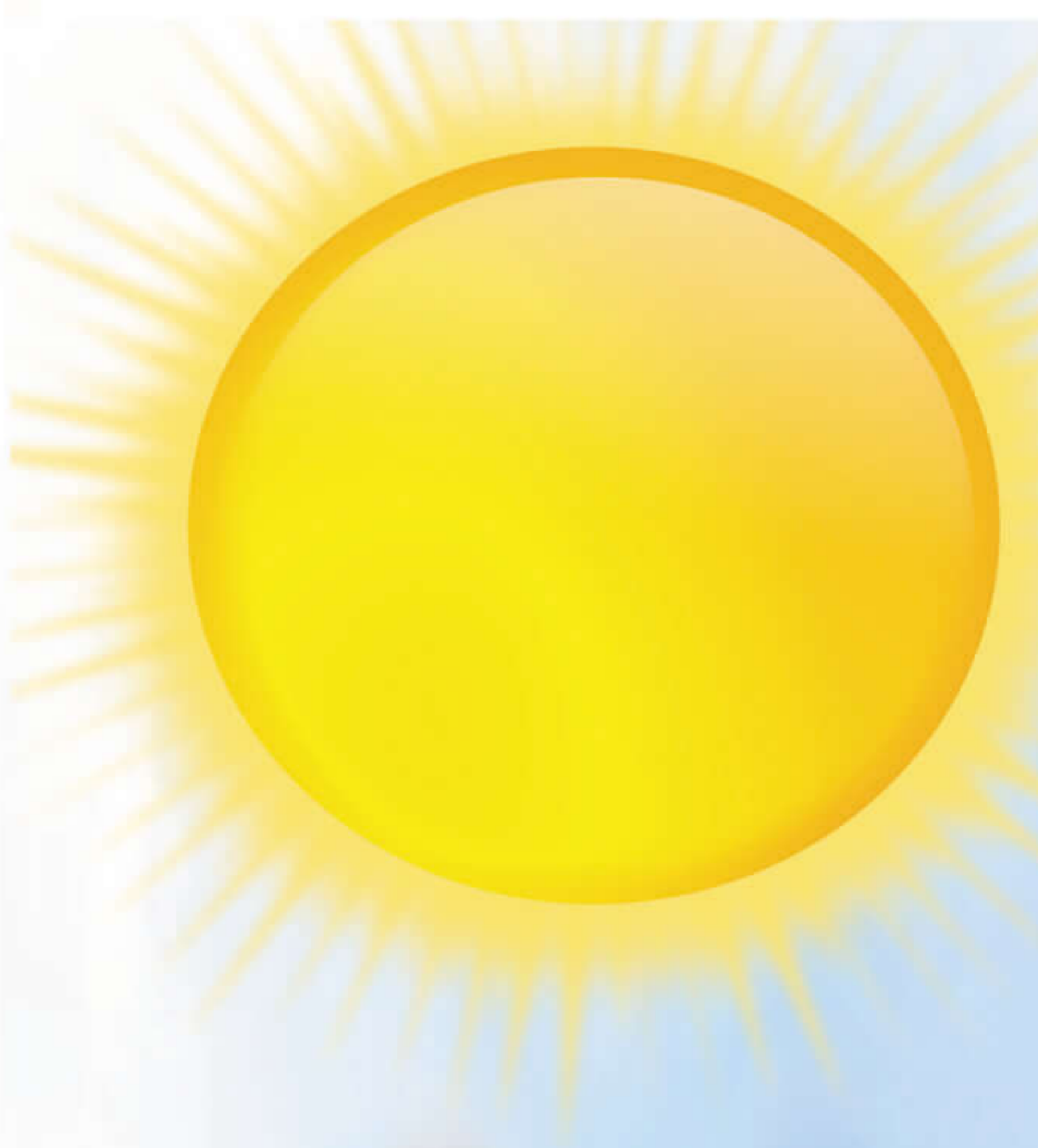

**54 202CL**  
**LED LEUCHT FRISBEE**

**XCLUB**

**2,55 Euro**

22 cm

25/100 Stk.



**54 181CL**  
**6 TLG. MINI GOLFSET**

**XCLUB**

**2,49 Euro**

63 cm lang

50/100 Stk.





**FRICTION MONSTER BUGGYS**

**53 144**

**2,49 Euro**

11 x 9 x 10 cm

8/96 Stk.



**SUPER FRICTION**



**GUMMI REIFEN**



Agricultural

**XCLUB**



**FARM MACHINERY**

Agricultural

AA069-59

SET YOUR IMAGINATION FREE AND TRY TO BUILD AS MANY COLOURED MODELS AS YOU CAN WITH THE PIECES YOU FIND IN THE BOX. FOLLOW THE PHOTOS ON THE BOX OR INVENT OTHER 1000 COLOURED MODELS OF YOUR OWN!



**6+**  
21PCS

**TRAKTOR BAUSATZ SORT. XCLUB**

**53 140CL**

**1,75 Euro**

9 x 10 x 3,5 cm

12/48 STK.





**FRICTION FLUGZEUG**

**53 136X**

**2,96 Euro**

47 x 15 x 5,2 cm

25/100 Stk.



**MIT LED INNENBELEUCHTUNG!**  
**MIT SOUND!**  
**MIT FRICTIONS-ANTRIEB!**



**METALLSPIELZEUG SORT. X CLUB**

**53 142CL**

**2,39 Euro**

12 x 9 x 3 cm

24 STK.



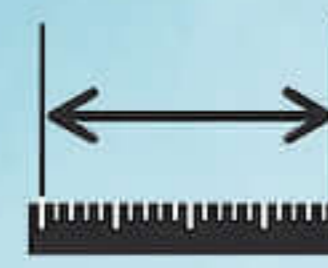

**53 606CL**  
**WACKELTURM X CLUB**  
**2,85 Euro**

 19 x 5,5 x 5,5 cm

 30/60 Stk.



NACHWACHSENDE  
ROHSTOFF



**53 537CL**  
**4 GEWINNT X CLUB**  
**2,89 Euro**

 12 x 18,5 x 3 cm

 50/100 Stk.

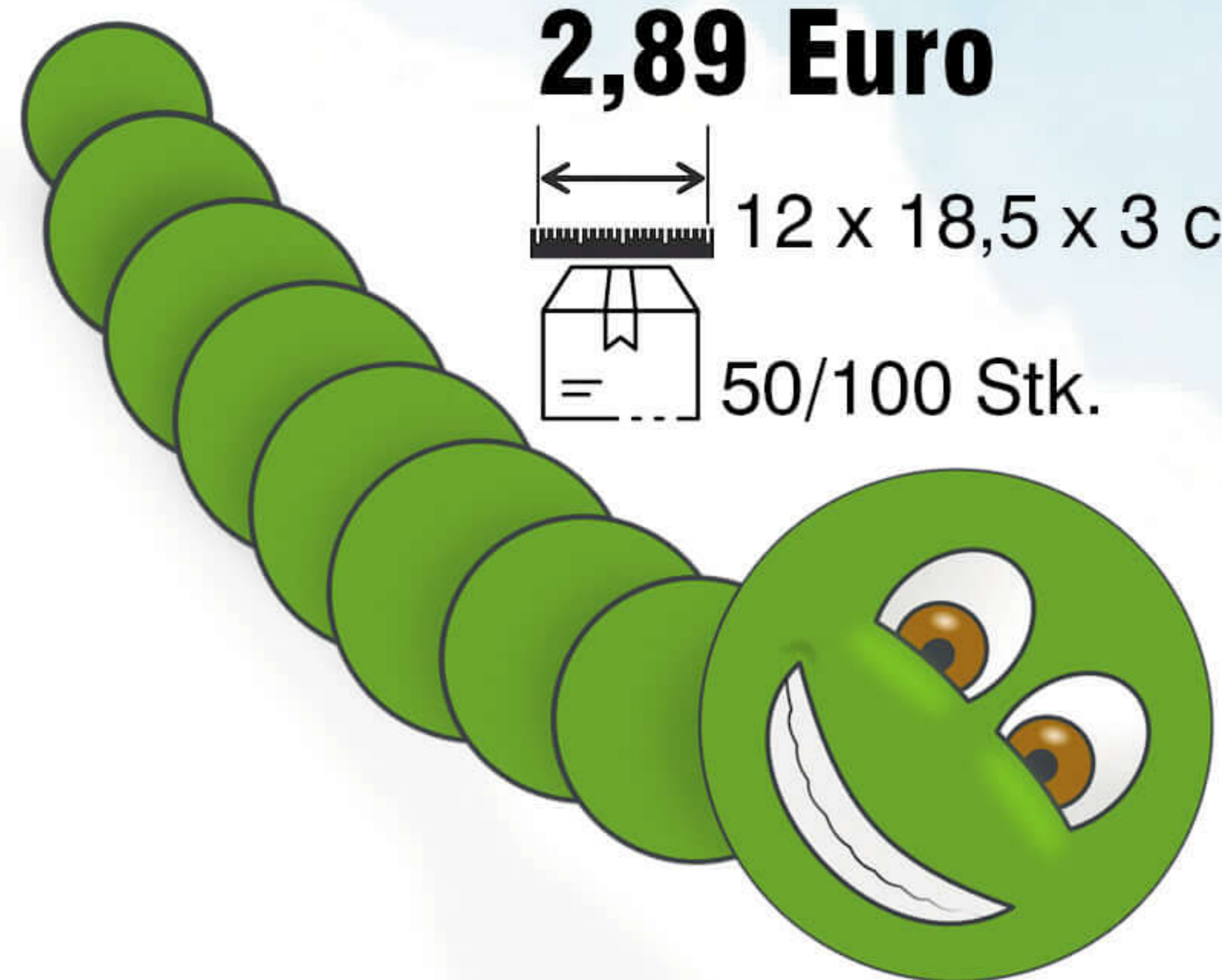

NACHWACHSENDE  
ROHSTOFF



**SPIELE SET MIKADO & DOMINO**

**X CLUB**

**53 885CL**  
**2,88 Euro**

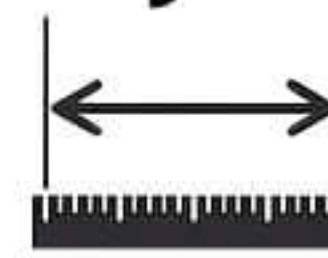
 19,6 x 9 x 3 cm

 30/60 Stk.



NACHWACHSENDE  
ROHSTOFF







UND AUS DEINEM **HANDY**



**XCLUB**  
**HANDY BILDSCHIRM**  
**60 155CL**  
**2,78 Euro**

19 x 12 x 1,5 cm

30/60 Stk.

WIRD IMMER & ÜBERALL EIN **BILDSCHIRM!**



**SONNENBRILLE SOFT TOUCH XCLUB**  
**60 314CL**  
**2,45 Euro**

4-10 Jahre

25/250 Stk.

bunt  
& auffällig



ideal für Kinder!



**BASEBALLKAPPE SCHÜLER XCLUB**  
**58 716CL**  
**2,95 Euro**

6-12 Jahre 25/150 Stk.







**REFLEKTOR SMILEYS X CLUB**

**54 449CL**  
**0,99 Euro**

13,5 x 20,5 cm

25/100 STK.



**18TLG. FAHRRAD REFLEKTOREN SET X CLUB**

**54 442CL**  
**1,96 Euro**

25 x 17 cm 50/100 STK.



**KABELSCHLOSS X CLUB**

**54 452CL**  
**2,80 Euro**

90 cm lang

24 STK.







**SPORTBEUTEL JUGEND XCLUB**

**57 721CL**

**2,45 Euro**

36 x 42 cm 30/12



**0,42L GLASTRINKFLASCHE MIT HÜLLE XCLUB**

**61 276CL**

**2,98 Euro**

19,5 x 6,3 cm 25/50 Stk.





**52 650CL**

**4TLG. BIEGE-LINEAL SET**

**XCLUB**

**1,87 Euro**

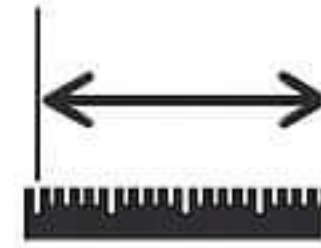
 36 x 20 cm

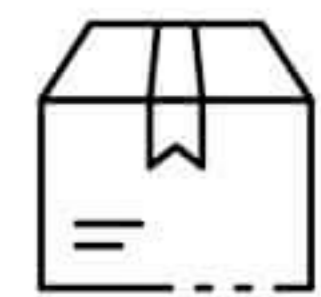
 50/100 Stk.



**55 252CL**  
**5 TLG. TEXTMARKER SET**

**XCLUB**

**1,95 Euro**

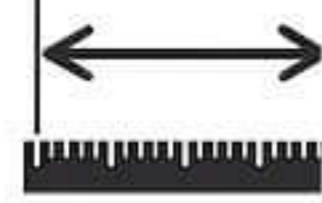
 10,5 x 9,4 x 1,8 cm

 50/200 Stk.

**52 652CL**  
**ZEICHENDREIECK**

**XCLUB**

**0,69 Euro**

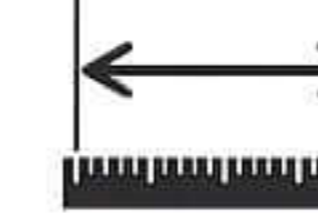
 15,5 x 0,8 x 3 cm

 24STK.

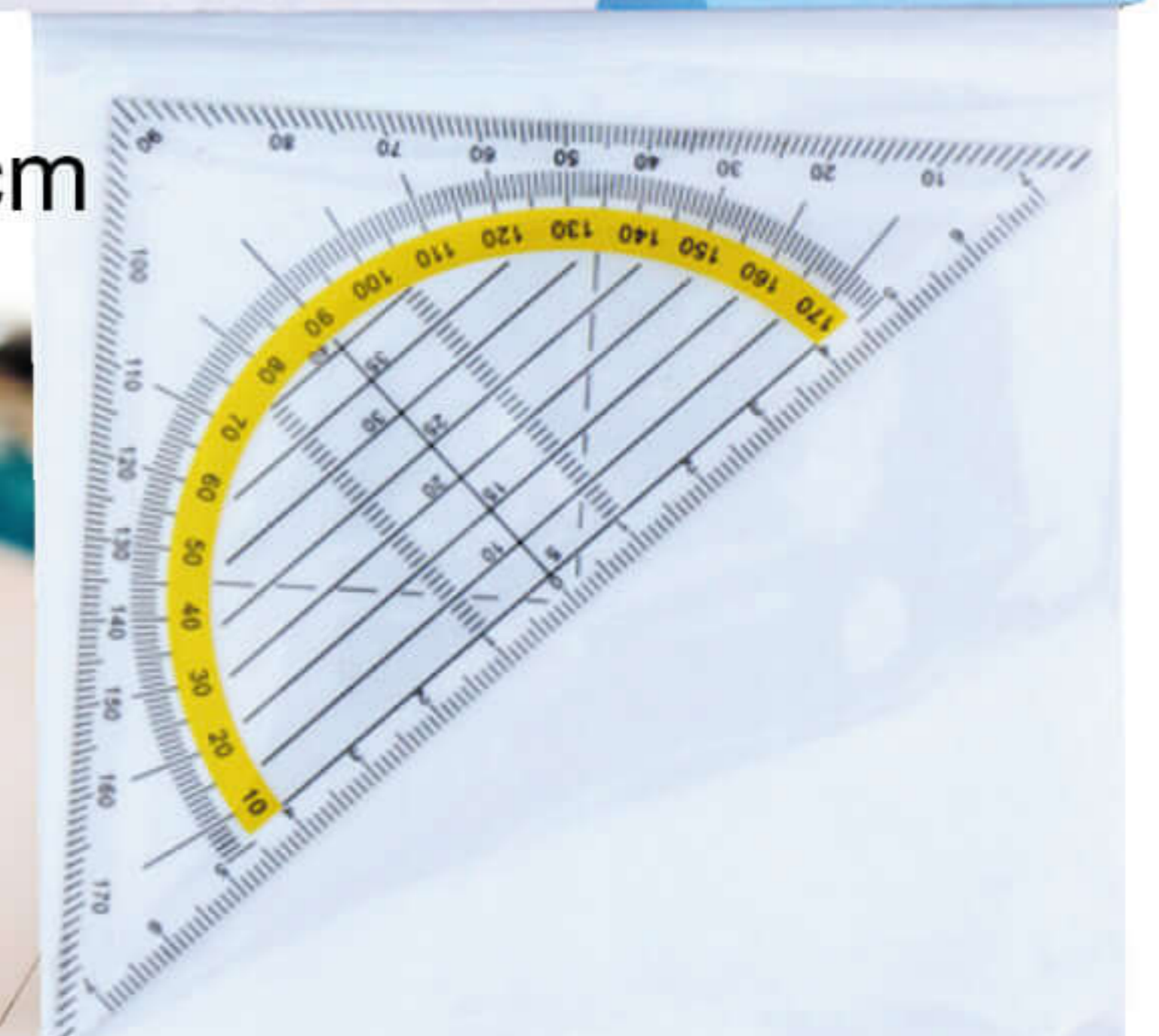

**55 753CL**

**NOTIZBUCH MIT POST ITS & KULI**

**XCLUB**

**2,48 Euro**

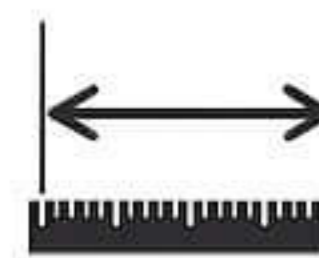
 16 x 13 cm

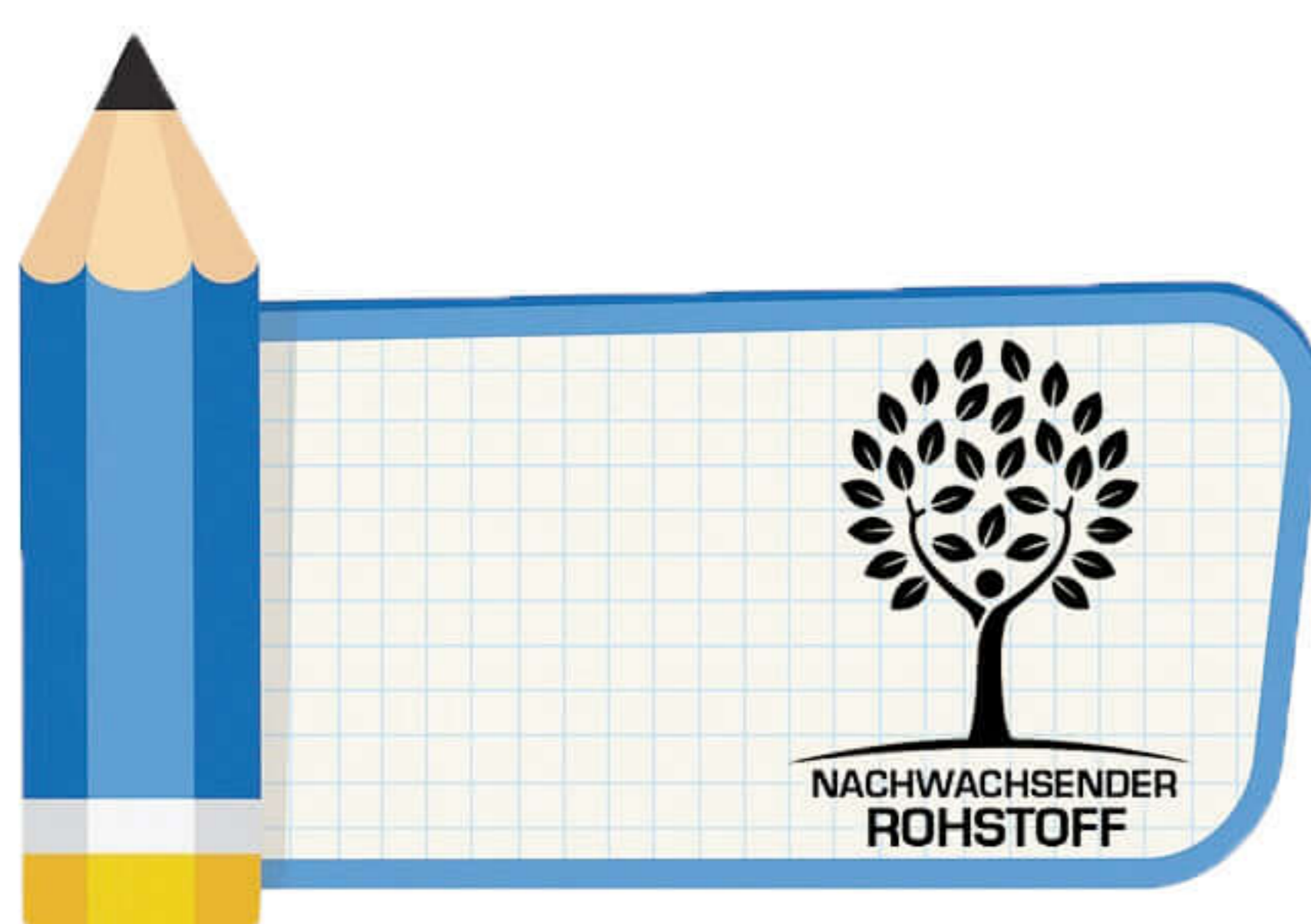

 50 Stk.







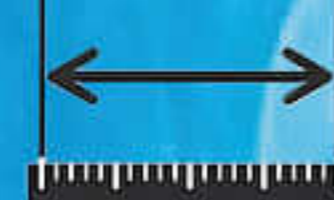

**WASSERSPRITZER X CLUB**  
**54 339CL**  
**1,89 Euro**

 35 cm lang  
 24/48 STK.



**2TLG. TAUCH SET X CLUB**  
**54 341CL**  
**1,98 Euro**

 16 x 30 cm  
 50/100 Stk.



**54 342CL**  
**SCHWIMMBRILLEN X CLUB**  
**2,49 Euro**

 24 x 14,5 x 21,5 cm  
 12/48 Stk.





**SPIELBALL MIT PUMPE REGENBOGEN X CLUB**

**54 195CL**  
**2,68 Euro**

 23,5 cm Durchmesser

 25/100 Stk.



**54 322CL**

**SPIEL-/BADE-DINO" X CLUB**

**1,99 Euro**

 18-22 cm

 30/60 Stk.



**54 336CL**

**SITZ-/NACKENKISSEN X CLUB**

**0,89 Euro**

 31 x 23 x 9 cm

 50/250 Stk.



**54 334CL**  
**WASSERBALL**

**X CLUB**

**1,19 Euro**

 30 cm

 25/250 Stk.

geprüfte Qualität / keine gefährlichen Weichmacher

**phthalatfrei**  
gem. Richtlinie 2005/84/EG





**PADDLEBALL SET MIT 2 BÄLLEN**

**XCLUB**

**54 129CL**

**2,89 Euro**

33 x 18,5 x 5 cm

50 Stk.



Softball

Gummiball



Springen  
Fitness



**54 141CL**

**SPRINGSEIL XCLUB**

**2,78 Euro**

48/144 Stk.



**FRISBEE sort. XCLUB**

**54 157CL**

**1,10 Euro**

20 cm

30/120 STK.





**54 127CL**  
**BADMINTON SET X CLUB**  
**9,85 Euro**

66 x 26 x 33 cm

24 Stk.



**PADDLEBALL SPIEL**



**4 TLG. PADDLEBALL**  
**SET X CLUB**  
**54 199CL**  
**14,95 Euro**

27 x 25 x 44 cm

1 STK.





**BASEBALLKAPPE JUGEND XCLUB**

**58 726CL**

**2,95 Euro**

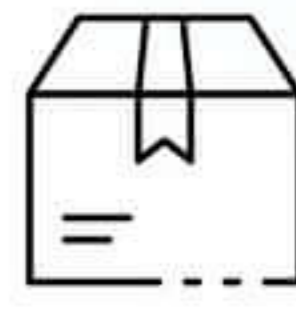
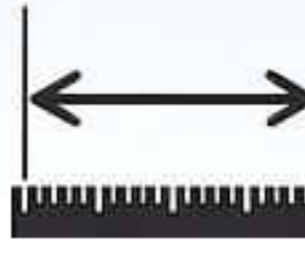

 25/150 Stk.  14+ Jahre



**SKATEBOARD sort. XCLUB**

**54 491CL**

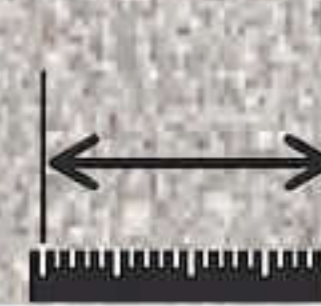
**19,90 Euro**

 57 x 15 x 9 cm  1 Stk.





**54 198CL**  
**FUSSBALL TOR X CLUB**  
**18,10 Euro**

 55 x 44 x 44 cm

 1 Stk.



**MATCH FUSSBALL X**  
**54 171X**  
**5,90 Euro**

 25/50 Stk.farblich sort.  
 18,8 cm Durchmesser



**SONNENBRILLE SOFT TOUCH XCLUB**

**60 307CL**  
**2,45 Euro**

25/250 Stk.

12,5 x 4,8 cm



**JUGEND MIKROFASER LIEGETUCH XCLUB**

**59 158CL**

**8,85 Euro**

70 x 150 cm

12/48 Stk.



**NEU!**

- BUNT**
- WEICH**
- LEICHT**
- RECYCLEBAR**
- PLATZSPAREND**
- SEHR SAUGFÄHIG**
- SANDABWEISEND**



- + NATURPRODUKT
- + AUS STROH
- + NACHHALTIG
- + RECYCLEBAR
- + EU PRODUKT

**STROHHUT PANAMA BRAUN**

**XCLUB**

**58 803CL**  
**3,40 Euro**

 unisize

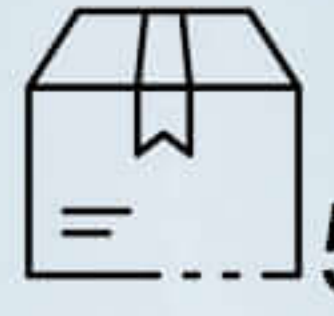
 50/100 Stk.



**SONNENBRILLE HOLZFINISH XCLUB**

**60 305CL**  
**2,45 Euro**

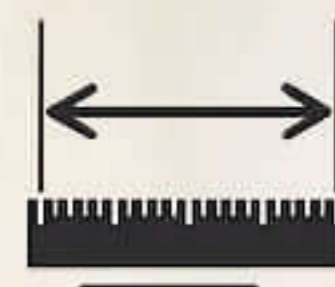
 33 x 11 x 1,50 cm

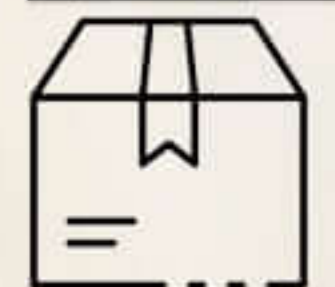
 25/250 Stk.



- + NATURPRODUKT
- + AUS STROH
- + NACHHALTIG
- + RECYCLEBAR
- + EU PRODUKT



**STROHHUT TEXAS BRAUN XCLUB**

**58 801CL**  
**3,40 Euro**

 unisize

 50/100 Stk.







**FÄCHER XCLUB**  
**60 220CL**  
**1,17 Euro**

23 x 43 cm  
60/240 Stk.



**ISOLIERTASCHE sort.**

**XCLUB**  
**57 998CL**  
**3,59 Euro**

20 x 14,5 x 14 cm  
10/200 STK.

**3W COB DUAL LAMPE XCLUB**  
**64 198CL**  
**2,99 Euro**

9 x 2,5 cm  
25/100 Stk.



**„BLACKOUT“ EMPFEHLUNG!**



- + LICHT EGAL WO, WANN & WIE LANGE
- + SELBER STROM ERZEUGEN
- + DURCH EINFACHES DRÜCKEN
- + HELLSTES LICHT GENERIEREN
- + UND AUCH SPEICHERN
- + MIT TRAGESCHLAUFE
- + KEINE BATTERIEN ERFORDERLICH!



**DIE HELLSTE MIT AKKU!**

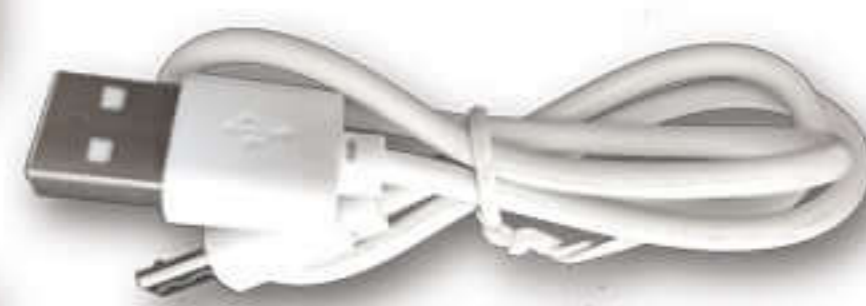

**DYNAMO BLACKOUT LED LAMPE**

**XCLUB**  
**64 202CL**  
**2,49 Euro**

10 x 5 x 3 cm  
30/120 Stk.

FLÄCHE  
PUNKT



**STRANDMUSCHEL X CLUB**

**54 523CL**

**18,- Euro**

 110 x 125 x 200 cm

 1 Stk.



**SCHLAFSACK X CLUB**

**54 524CL**

**18,50 Euro**

 1 Stk.

**190 x 75 cm**





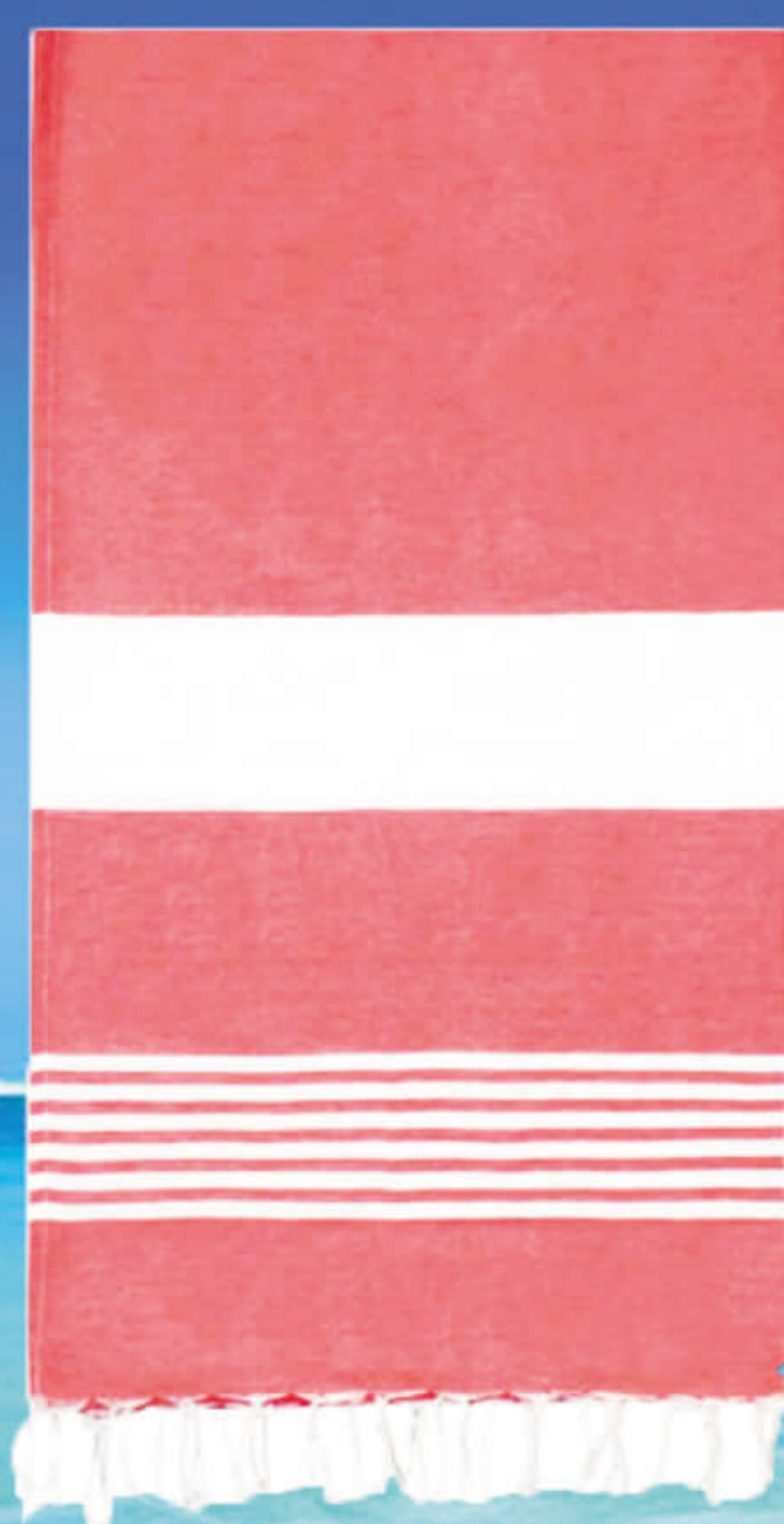
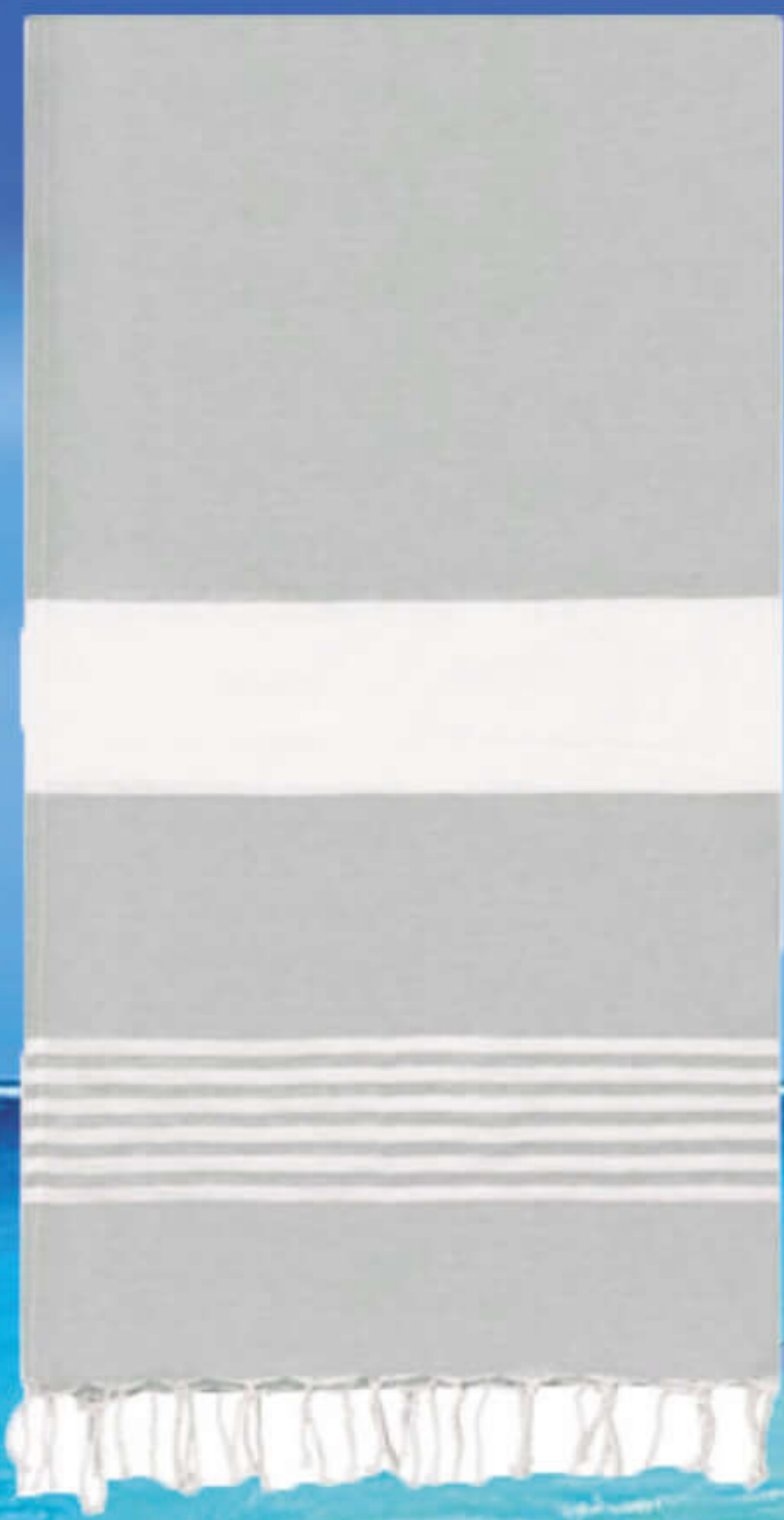

**BADETUCH X CLUB**

**59 670CL**

**9,98 Euro**

180 x 90 cm

25 Stk.



**100% BAUMWOLLE**



**WASSER HÄNGEMATTE X CLUB**

**54 335CL**

**8,49 Euro**

108 x 73 cm

12 Stk.



**JUGEND RUCKSACK XCLUB**

**57 549CL**

**8,24 Euro**

42 x 31 x 13 cm

12/24 Stk.

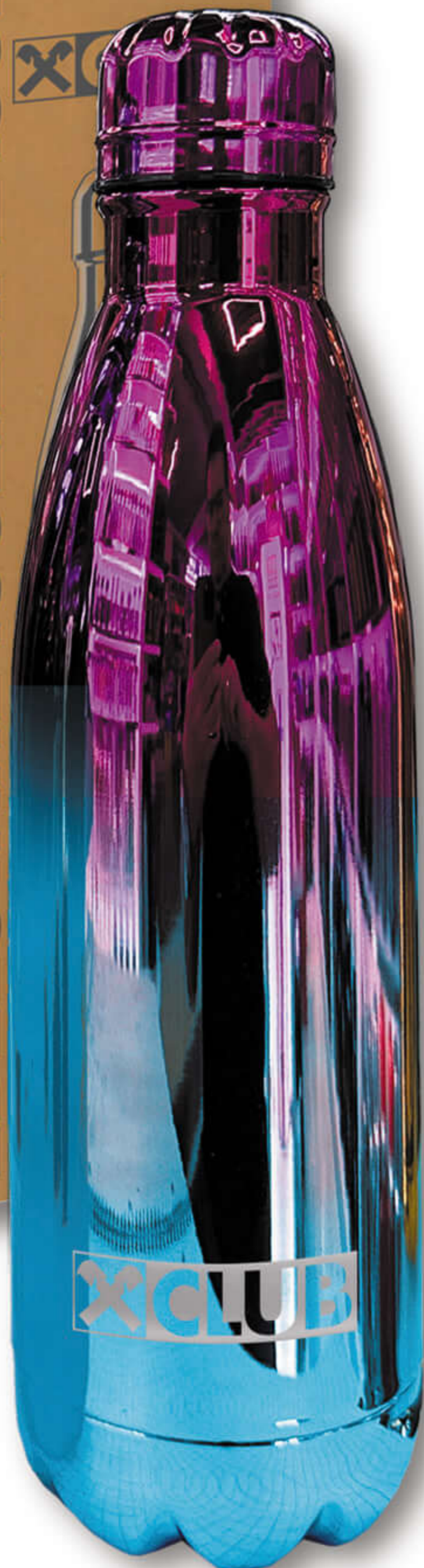

**0,5L ISOLIERFLASCHE**

**XCLUB**

**61 250CL**

**9,90 Euro**

27 x 7 cm

24/48 Stk.





**57 639CL**

**JUGEND FREIZEITTASCHE XCLUB**

**8,-- Euro**

45 x 25,5 x 21,5 cm

24 Stk.



**POWER FÖN-SET 1200 WATT**

**XCLUB**

**63 331CL**

**9,36 Euro**

21,5 x 8 x 12,5 cm

36 Stk.





## ZIPP-KOPFHÖRER MIT MIKRO

**XCLUB**

**63 197CL**  
**1,99 Euro**

14 x 8 x 2 cm

60/120 Stk.

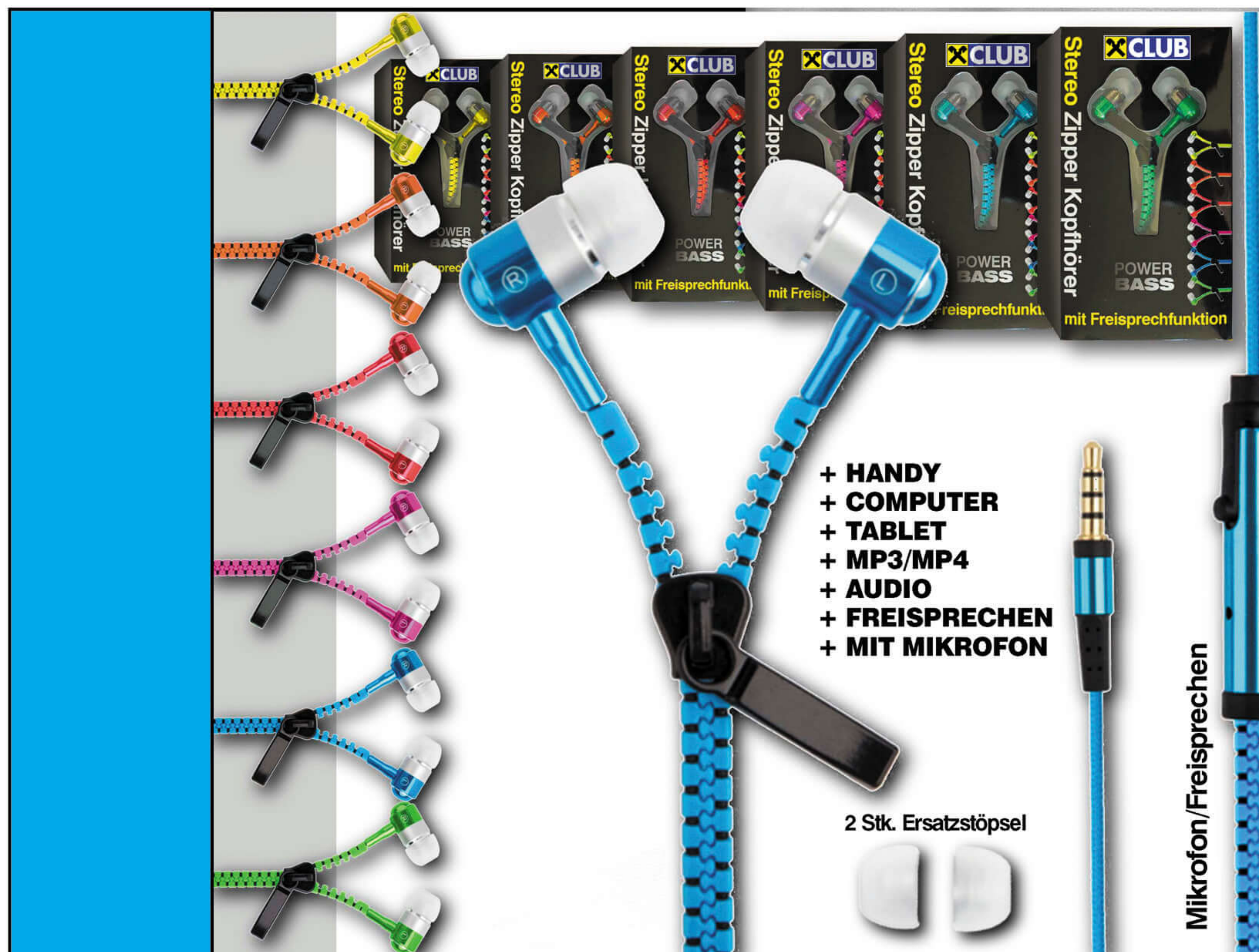

## RUCKSACK COLOUR XCLUB

**57 519CL**  
**6,46 Euro**

38 x 28 x 15 cm

24/48 STK



## ROLLENTASCHE KIDS XCLUB

**57 529CL**  
**5,51 Euro**

40 x 20 cm

24/48 Stk.







**60 091CL**  
**SCHLÜSSELANHÄNGER**  
**XCLUB**

**1,77 Euro**

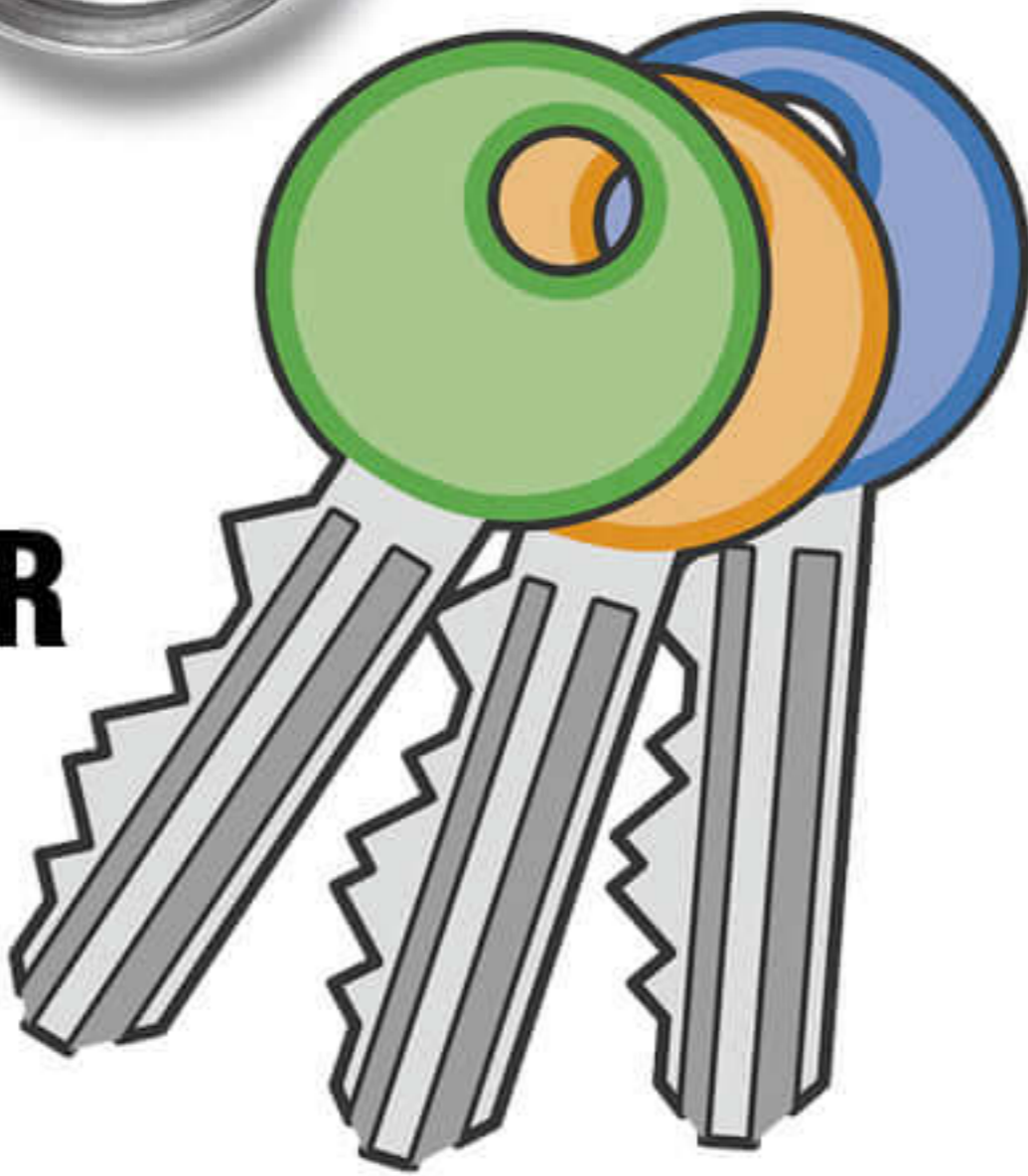
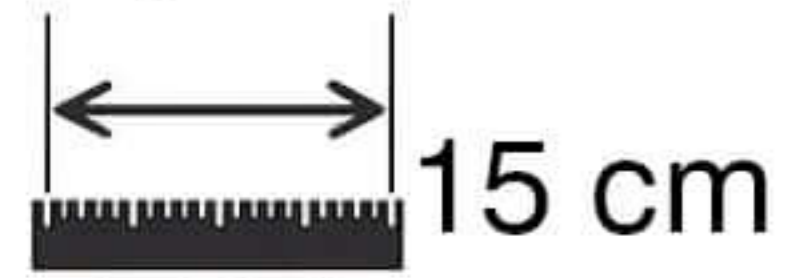

**FALTBAR**



**FLEXI GÜRTELTASCHE XCLUB**  
**60 153CL**  
**2,59 Euro**

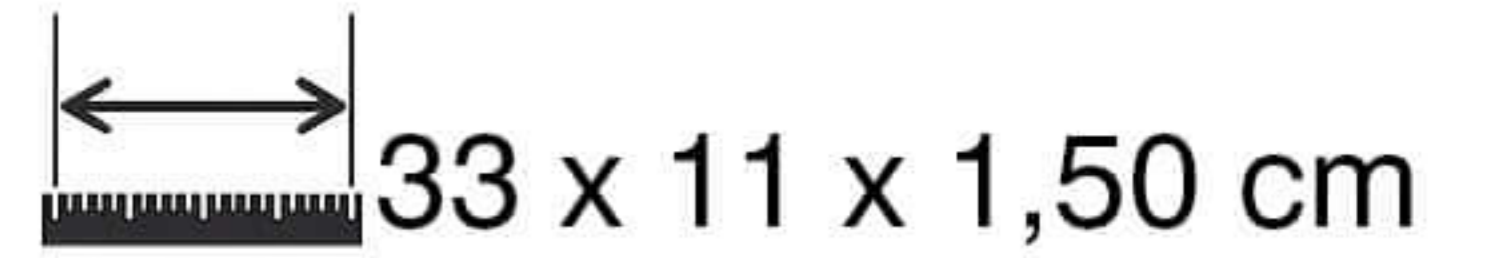

**KOPFHÖRER POWERPASS**  
**XCLUB**

**GRÖSSENVERSTELLBAR**

**63 198CL**  
**6,93 Euro**

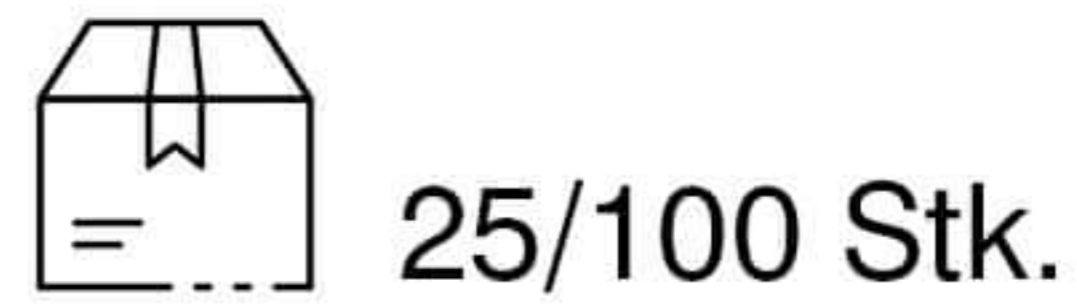
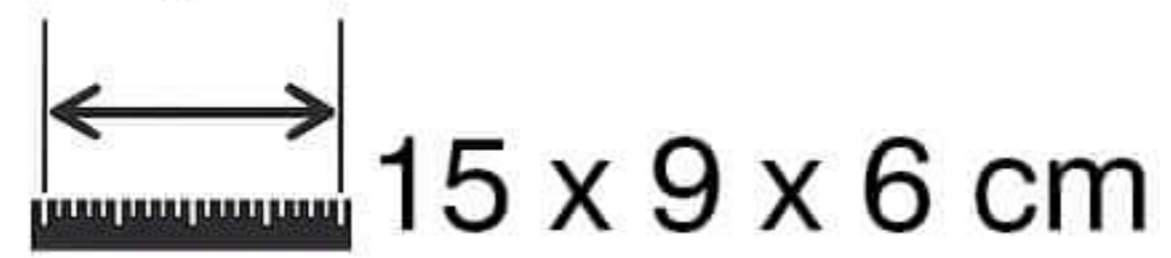



**JUGEND TROLLEY TASCHE**

**XCLUB**

**57 839CL**

**27,10 Euro**

 75 x 33,5 x 36,5 cm

 6 Stk.



**FREIZEITTASCHE LETTER**

**XCLUB**

**57 650CL**

**9,12 Euro**

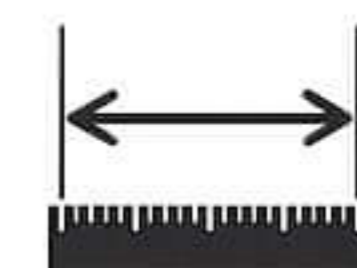
 45 x 25 x 25 cm

 15/30 Stk.

**TOILETTE-TASCHE XCLUB**

**57 470CL**

**2,36 Euro**

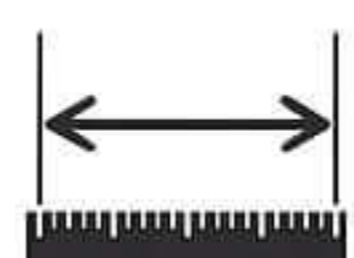
 32 x 22 x 9 cm

 25/100 Stk.





**3W COB STIRNLAMPE XCLUB**

**64 196CL**  
**2,95 Euro**

7 x 5 x 7 cm 50 / 100Stk.



**9LED TASCHENLAMPE COLOUR**

**XCLUB**

**64 187CL**  
**2,49 Euro**

14 x 3 x 3 cm 25/100 Stk.

**3 FUNKTIONEN:**

1. 100% LICHT
2. 50% LICHT
3. BLINKLICHT
4. AUS



**SMARTPHONE STATIV**

**XCLUB**

**60 162CL**  
**2,31 Euro**

25 cm hoch  
100 Stk.



**USB-C**

**UNIVERSAL USB LADEADAPTER XCLUB**

**60 160CL**  
**3,25 Euro**

9,5 x 5 x 3 cm  
25/200 Stk.



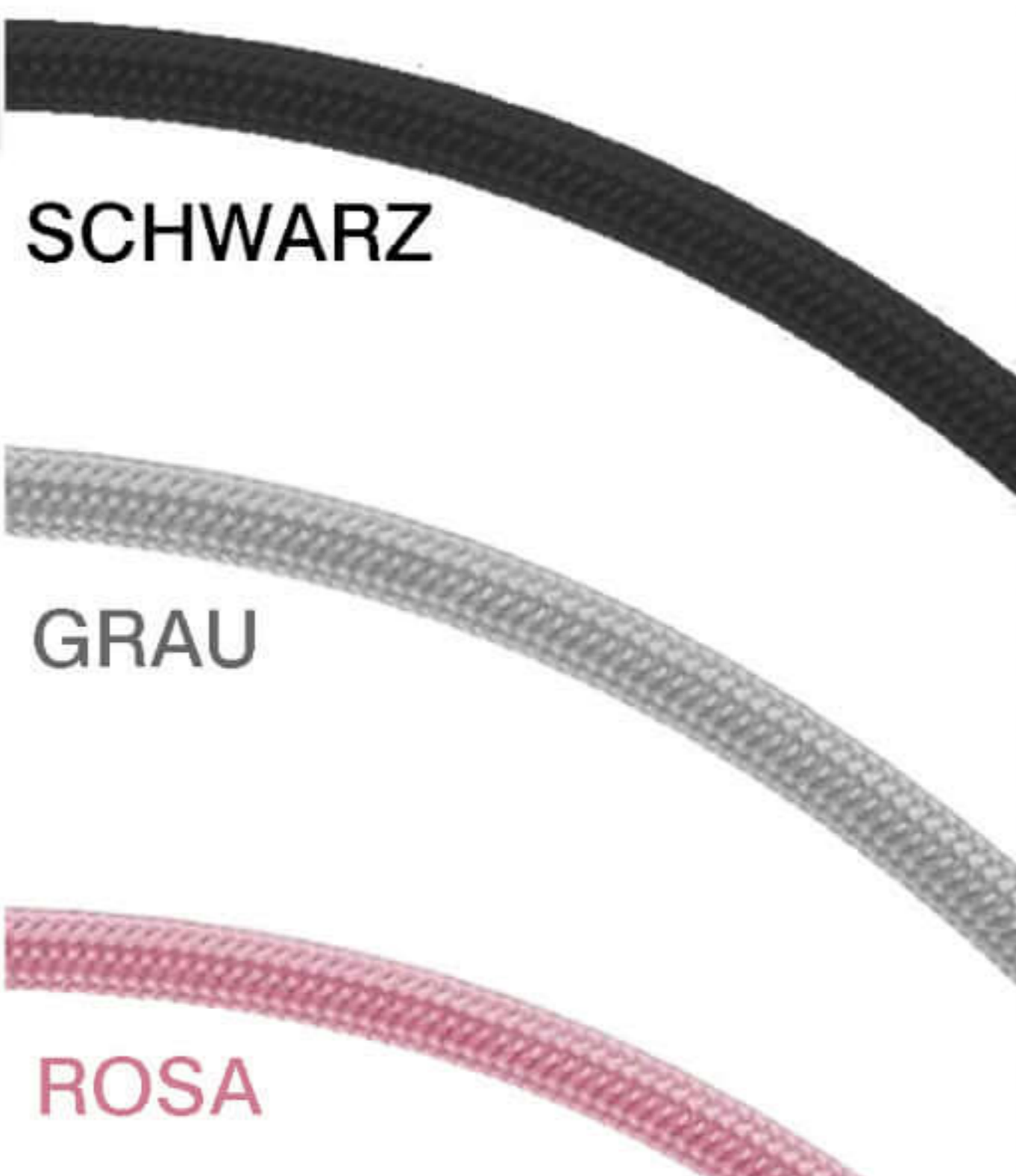

- durch Ziehen an den Kordelenden kann man die Länge des Bandes stufenlos verstellen
- Handy stets griffbereit
- Hände immer frei
- einfachst zu Montieren
- passt zu 99% aller Hüllen
- cool & trendy



*trendig  
praktisch  
cool & modern*

**UNIVERSAL HANDYBAND XCLUB**

**60 149CL**  
**2,59 Euro**

140 cm lang

25/200 Stk.



**BLUETOOTH MAGNET KOPFHÖRER**

**XCLUB**

**60 161CL**  
**2,96 Euro**

17 x 9 x 2,5 cm

25/100 Stk.



**MAGNET**



**Bluetooth**  
**KABELLOS**  
**FÜR JEDES HANDY**





**0,6L ÖKO GLASFLASCHE XCLUB**  
**61 277CL**  
**3,95 Euro**

24,5 x 7 cm  
18/36 Stk.



- + **UMWELTFREUNDLICH**
- + **AUS WEIZENSTROH**
- + **SPÜLMASCHINENFEST**
- + **MIKROWELLENGEEIGNET**
- + **EINFACHSTE VERWENDUNG**
- + **LEBENSMITTELECHT**



**JAUSEDOSE JUGEND**  
**XCLUB**  
**62 142CL**  
**3,15 Euro**

19,5 x 14,6 x 7,8 cm 30/60 Stk.



**ZAHLENSCHLOSS X CLUB**  
**54 435CL**  
**4,72 Euro**

80 cm lang  
25/50 STK.

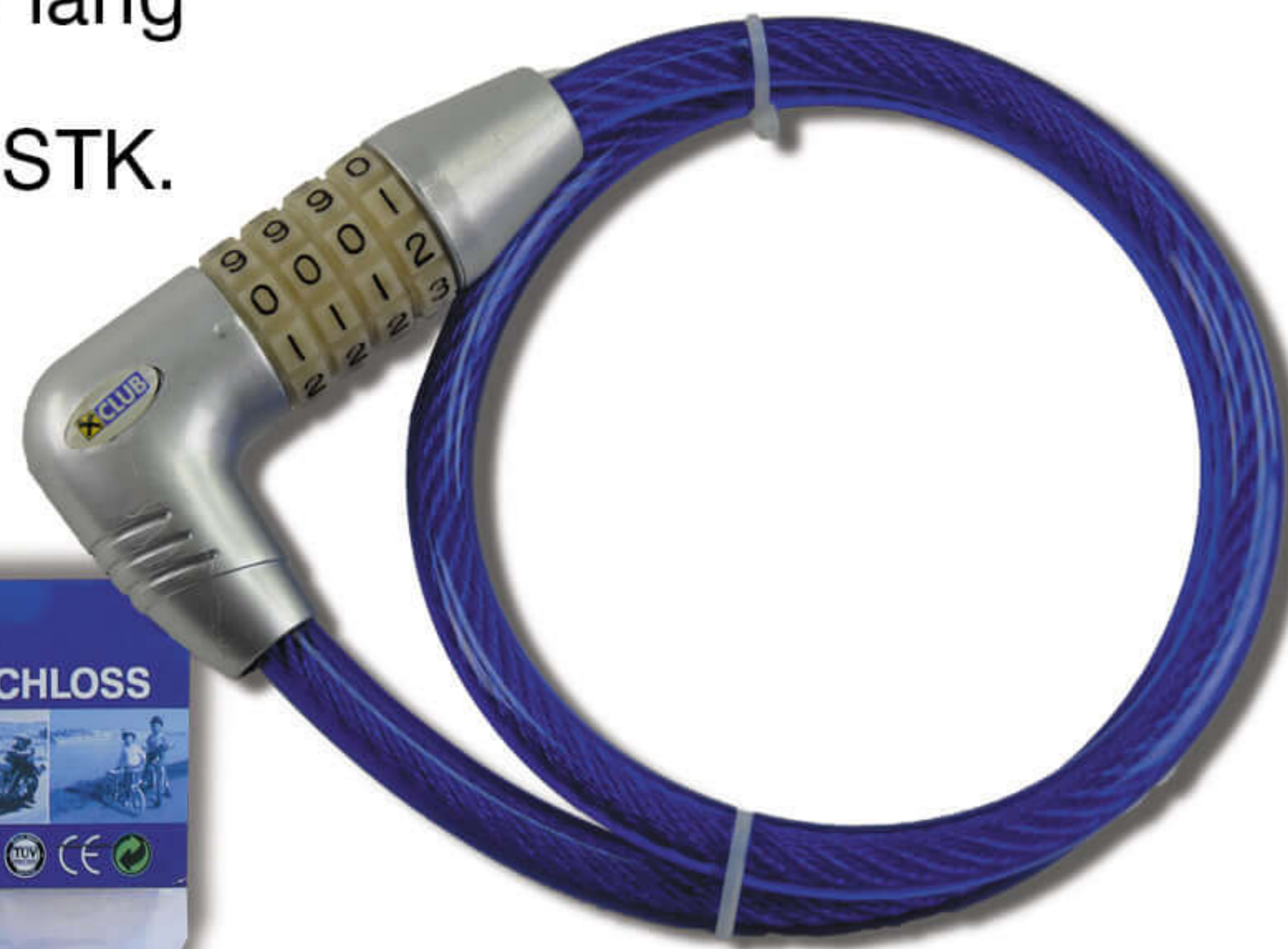

360° drehbar



stufenlos größenverstellbar



ohne Werkzeug montierbar



+ LEICHTE MONTAGE + 360° VOLL DREHBAR  
+ SICHERER HALT + GRÖSSENVERSTELLBAR



**GEBRAUCHSANWEISUNG:**  
Diese solide, praktische Handyhalterung lässt sich für alle Handysgrößen bis 95 x 85 mm und einer Dicke von 12 mm vertikal oder horizontal einfach und ohne Werkzeug an der Balance Ihres Fahrrades, E-Bikes, Mopeds oder Motorrades mit einem Durchmesser von 18 bis 38 mm montieren. Sie können zuerst die Halterung montieren und mit der Stellschraube 4 mit Gefühl fixieren. Dann lösen Sie mit der Schraube 2 die Anverlebung der Ecken und führen durch Drehen an der Schraube 1 die Ecken weit auseinander. Nehmen Sie nun Ihr Handy und passen Sie es durch Drehen der Schraube 1 ideal in die Eckhalterungen ein. Wenn Ihr Handy fest sitzt führen Sie die Eckhalterungen in ihrer Position durch Drehen der Schraube 2. Nun können Sie noch durch Drehen und Fixieren der Schraube 3 den optimalen und gewünschten Neigungswinkel der Halterung einstellen. Die Halterung ist 360° drehbar und verstellbar!

- 1 Erweitern oder zusammenziehen der Eckhalterungen
- 2 Ändern oder Lösen der Eckhalterungen
- 3 Neigungswinkel der Halterung feststellen oder lösen
- 4 Halterung an der Fahrradbalance feststellen oder lösen

**ACHTUNG:**  
Bei aktiver Teilnahme am Straßenverkehr ist Telefonieren verboten. Bitte denken Sie daran, dass Ihr Telefon Sie ablenken kann & Sie dadurch in eine gefährliche Situation geraten können.



**HANDYHALTER FAHRRAD X CLUB**

**54 448CL**  
**3,45 Euro**

13 x 11 x 12 cm  
50/100 STK.

**SPORTHANDTUCH X CLUB**  
**59 671CL**  
**3,80 Euro**

80 x 40 cm  
15 STK.



**3 SCHRITTE ZUR AKTIVIERUNG:**



BEFEUCHTEN



AUSWINDEN



SCHÜTTELN





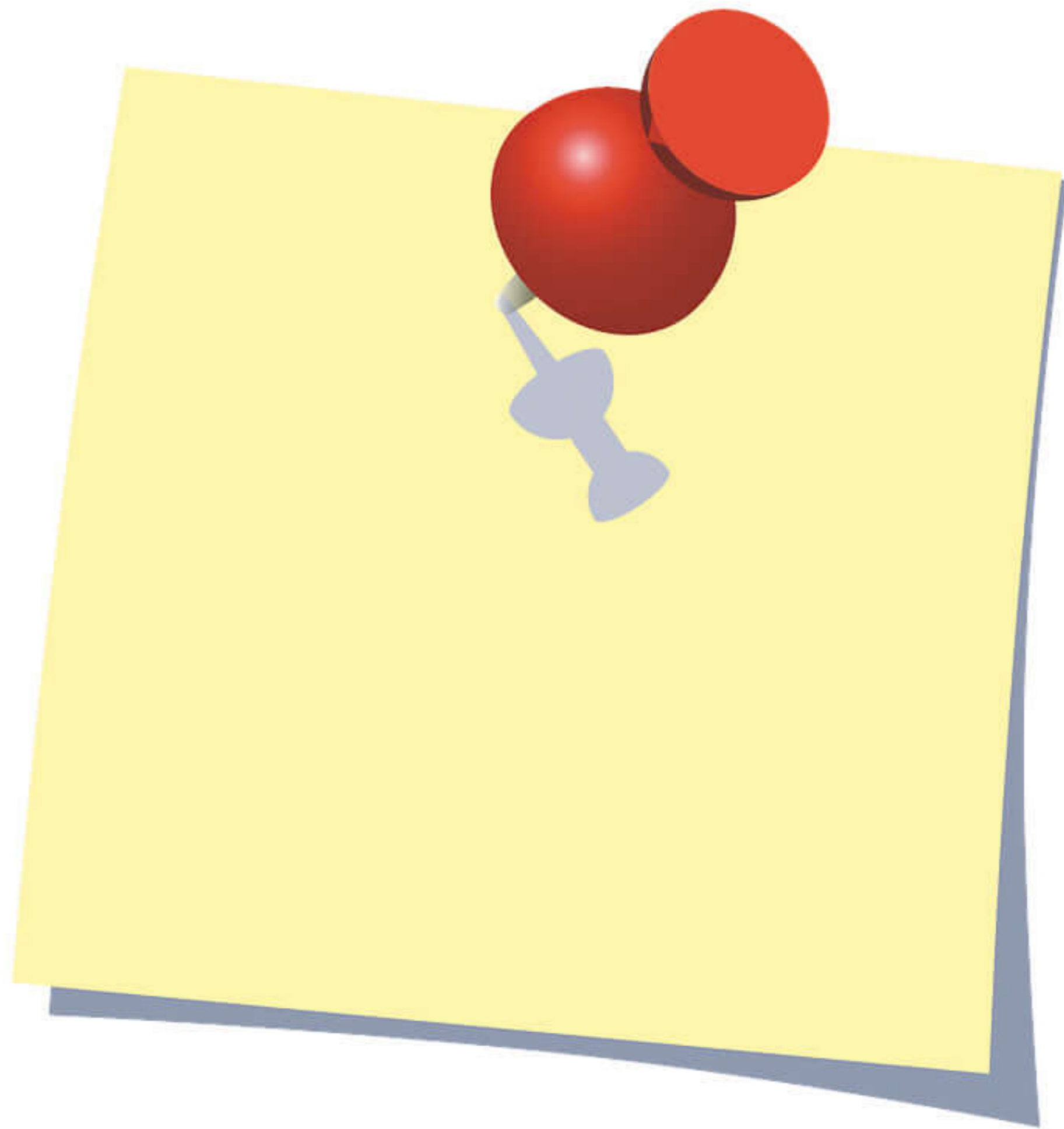

**TISCHRECHNER XCLUB**  
**63 744CL**  
**1,99 Euro**

15 x 12 x 4 cm  
 50/100 Stk.

**2TLG. SCHREIBSET XCLUB**  
**55 285CL**  
**2,67 Euro**

17,5 x 6 x 2,5 cm  
 50/100 Stk.



einzel im Karton



mit drehbarem Verschluss

- 63 933CL/4GB**    **USB STICK 2.0 4GB XCLUB**    **2,99 Euro**
- 63 933CL/8GB**    **USB STICK 2.0 8GB XCLUB**    **3,34 Euro**
- 63 933CL/16GB**    **USB STICK 2.0 16GB XCLUB**    **3,86 Euro**
- 63 933CL/32GB**    **USB STICK 2.0 32GB XCLUB**    **4,89 Euro**

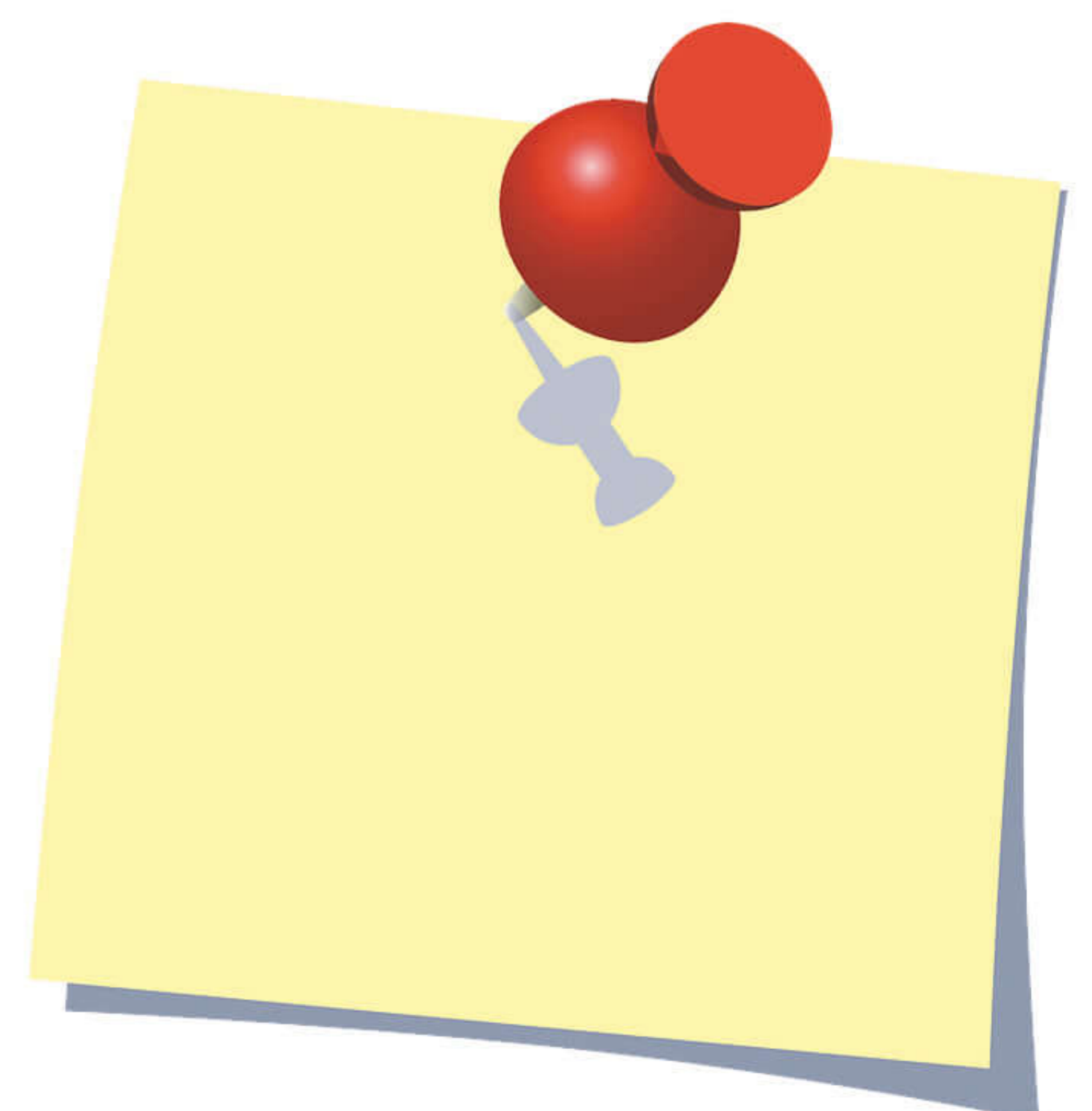



**KAUFMANN**

WERBEGESCHENKE



**3IN1 FUNKTIONEN:**  
+ KUGELSCHREIBER  
+ LED LEUCHTLOGO  
+ TOUCH-FUNKTION



**55 186CL**  
**3 IN 1 LED KUGLER**  
**XCLUB**  
**1,65 Euro**  
16 cm  
60/360 Stk.

**KARTENETUI-METALL XCLUB**  
**56 768CL**  
**2,55 Euro**  
9,5 x 6,3 x 0,8 cm  
25/250 Stk.

**WANDUHR 90 CM XCLUB**  
**63 466CL**  
**9,60 Euro**  
90 cm lang 1 Stk.

**XCLUB**

# WANDUHR

**Einfach riesig: 90 cm lang!**

- ⊙ Hochwertiges Quarzwerk
- ⊙ Nachleuchtende Zeiger und Zifferblattanzeigen
- ⊙ Leichtes Ablesen dank großer Zeiger
- ⊙ Einfache Befestigung
- ⊙ 700 Gramm leicht

**BUNT, COOL, RIESIG!**

# WANDUHR

**90 cm lang**

**BUNT, COOL, RIESIG!**



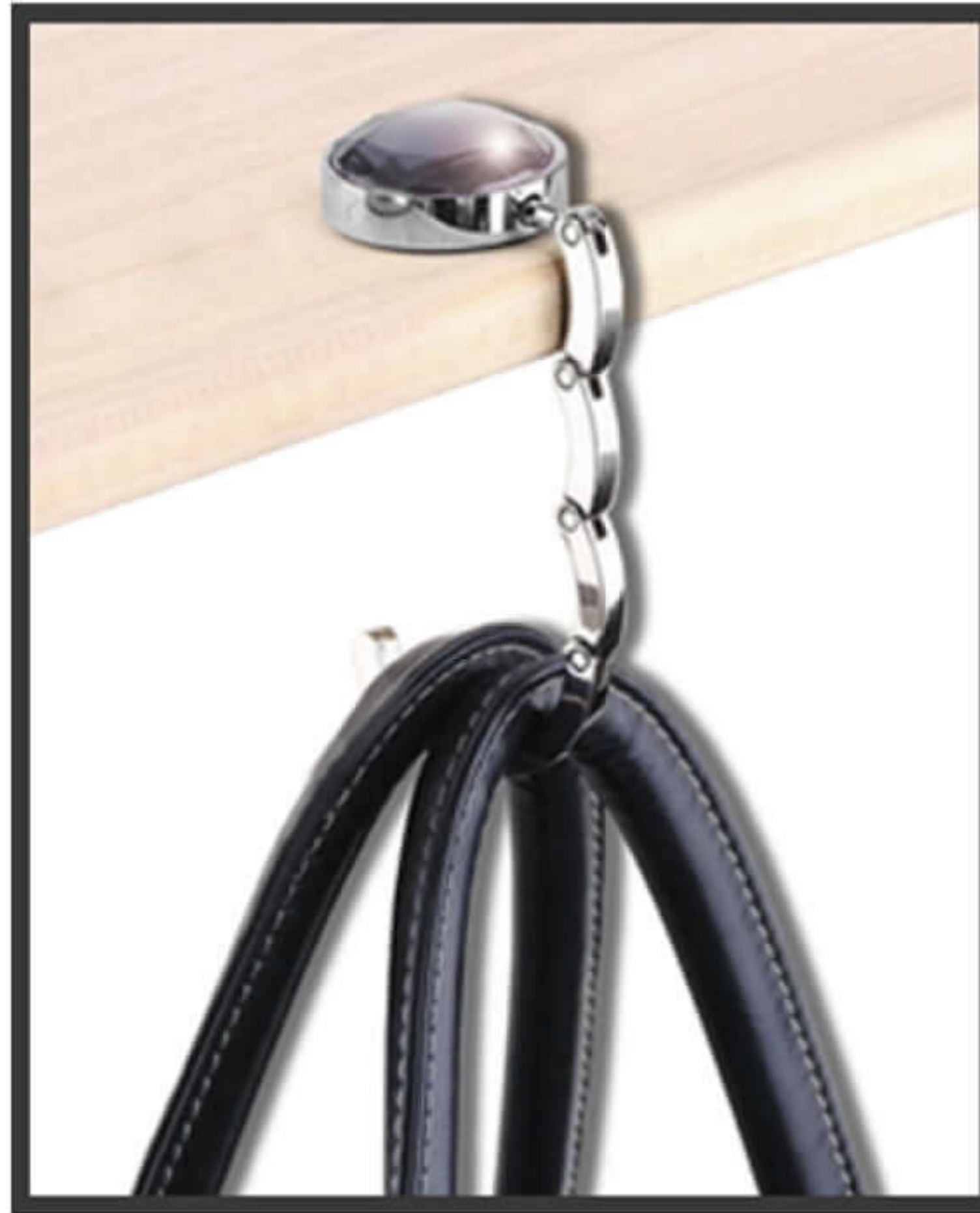

HANDTASCHEN HÄNGER



TASCHENSPIEGEL

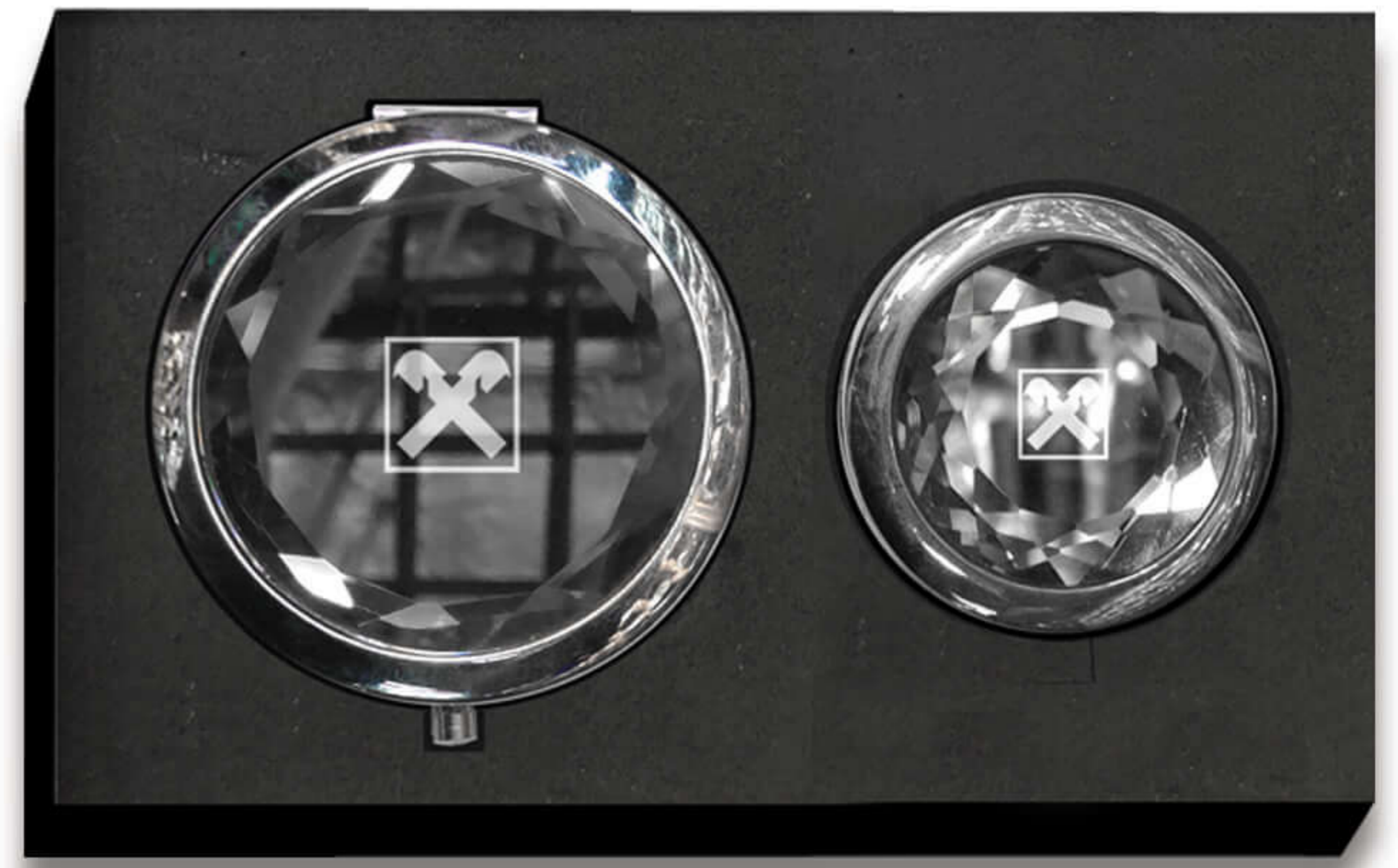

**60 224X**  
2 TLG. DAMEN SET

**5,33 Euro**

15 x 10 x 1,5 cm 25/100 Stk.

**60 225X**  
4 TLG. DAMEN SET

**9,90 Euro**

16 x 16 x 2 cm 25/100 Stk.

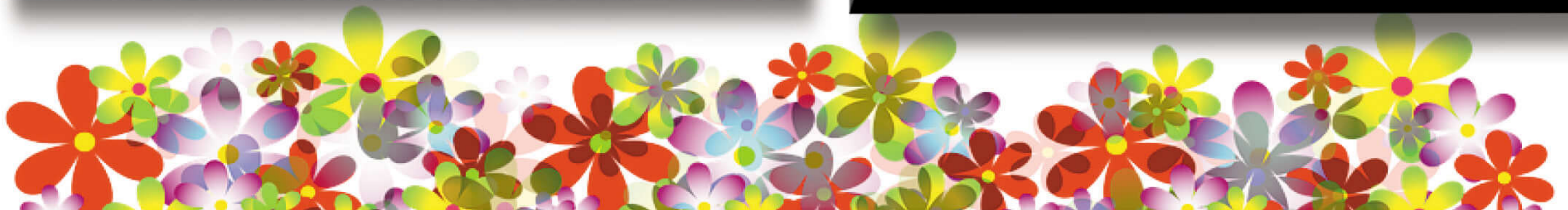
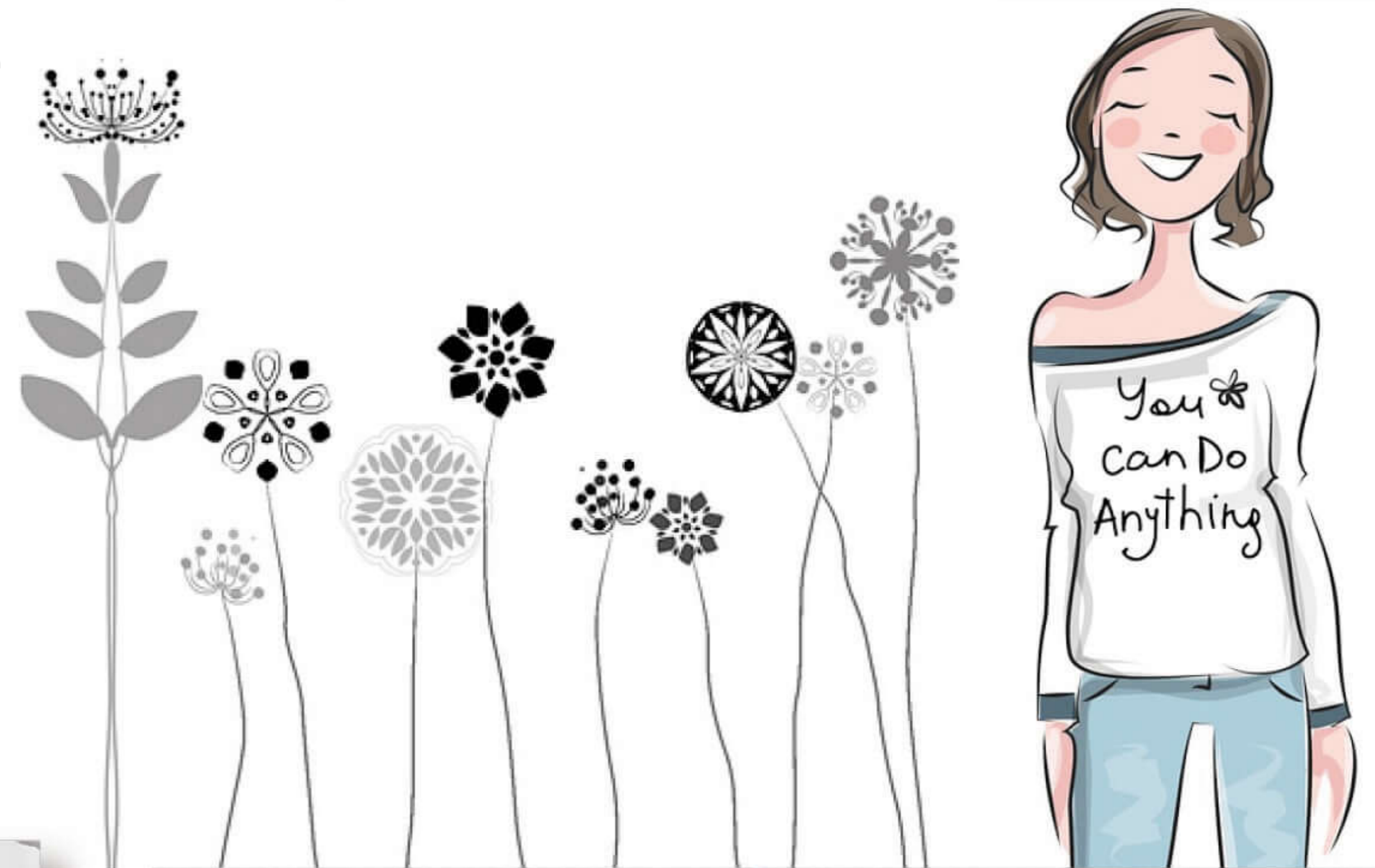

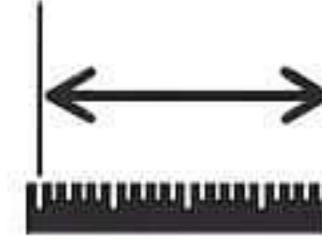
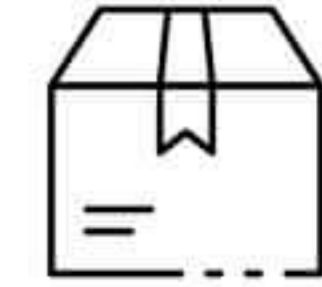

**60 222X**  
**HANDTASCHEN-HÄNGER**   
**2,67 Euro**

 4,5 cm  
 25/100 Stk.

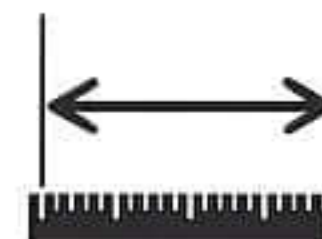
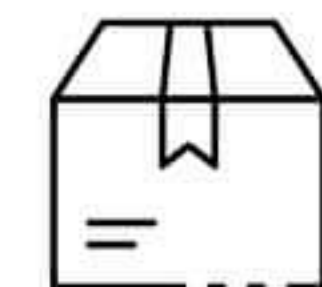

**60 221X**  
**DAMEN FÄCHER**   
**1,17 Euro**

 23 x 43 cm  
 60/240 Stk.

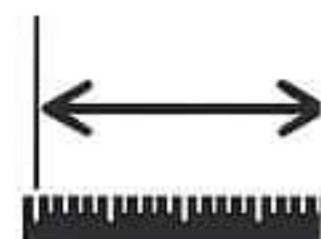
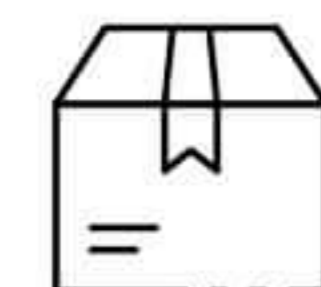

**60 223X**  
**KOSMETIK SPIEGEL**   
**2,67 Euro**

 7 cm  
 25/100 Stk.





**UWE KAUFMANN E.U.**

**Stefan Fadinger Str.6  
4722 Peuerbach  
Austria**

**[tel]                   +43 (0)7276 3995  
[fax]                   +43 (0)7276 3995 33  
[email]                info@kaufmann-trading.com  
[web]                   www.kaufmann-trading.com**